

SHAD

ENGINEERED FOR RIDING



MORE INFO



NEW TERRA SADDLE BAGS / **TR40**

WWW.SHAD.ES

SRP PRICE LIST

COMPANY

P. 4

P. 26

CASES

TERRA



TOP



SIDE



ACCESSORIES



FITTING KITS



COMFORT SEATS



SPORT



TOURING



SCOOTER BAG



PIN SYSTEM



CAFE RACER



ADVENTURE



ACCESSORIES FOR BAGS



RIDER

SMARTPHONE HOLDERS NEW



RAIN JACKETS



RAIN PANTS



HAND MUFFS



ATV CASES



SHAD LOCKS



FULLY EQUIPPED

P. 126

SPARE PARTS

P. 127

SHAD SUPPORT

P. 127

DISPLAYS

P. 128

ICONS

P. 130

SRP PRICE LIST (VAT INCLUDED)

CIAO
HOLA



CATALOGUE LANGUAGES:
Find your translation scanning this QR Code.

Conditions of purchase ⁽¹⁾

Recommendations

- SHAD recommends keeping our suggested public price on e-commerce sites (Suggested Retail Price).
- SHAD recommends checking the current legal regulations for any installation that involves the alteration of any original component of the motorcycle.

sembly indicated by the brand. The end customer is entitled to request the guarantee of his/her product, always provided with the proof of purchase (purchase receipt, invoice or cash receipt).

NOTE: ALL TESTS OF OUR PRODUCTS HAVE BEEN CARRIED OUT WITH THE ORIGINAL (UNMODIFIED) MOTORCYCLES.

Guarantee and claims

All SHAD products are subject to a limited warranty (minimum of 24 months from the date of purchase), modifiable according to the current legislation of each country; according to the proper use and correct as-

The assembly of the SHAD products on in third-party mounting plates and racks, as well as the alteration, MODIFICATION OR ALTERATION of our products or original motorcycle elements will not be covered by the SHAD warranty.

Condiciones de compra ⁽¹⁾

Recomendaciones

- SHAD recomienda mantener en los apartados públicos de cualquier web nuestro precio público sugerido (Suggested Retail Price).
- SHAD recomienda verificar la normativa legal vigente para cualquier instalación que suponga la alteración de cualquier elemento original de la moto.

usen correctamente, de acuerdo con el uso adecuado y el ensamblaje correcto indicado por la marca. El cliente final tiene derecho a solicitar la garantía de su producto, siempre con el comprobante de compra (recibo de compra, factura o recibo de caja).

NOTA: TODAS LAS PRUEBAS DE NUESTROS PRODUCTOS HAN SIDO REALIZADAS CON EL EQUIPAMIENTO DE SERIE EN LAS DIFERENTES MOTOCICLETAS Y MODELOS,

Garantías y reclamaciones

Todos los productos SHAD están sujetos a una garantía limitada (mínima de 24 meses desde la fecha de compra), modificable según la legislación vigente de cada país; siempre y cuando, los productos se

El montaje del producto SHAD en fijaciones y parrillas de terceros, así como la alteración, MODIFICACIÓN O REFORMA de nuestros productos o de elementos originales de la moto suponen la pérdida de la garantía.

Condition d'achat ⁽¹⁾

Recommandations:

- SHAD recommande de conserver notre prix public suggéré (Suggested Retail Price) dans les sections publiques de n'importe quel site Web.
- SHAD recommande de vérifier la législation en vigueur pour toute installation qui implique la modification de tout élément d'origine de la moto.

utilisés correctement, en fonction de l'usage prévu et du montage recommandé par la marque. Le client final est en droit de faire une demande de garantie sur son produit toujours avec la preuve d'achat (facture, reçu ou ticket de caisse).

NOTE : TOUS LES TESTS DE NOS PRODUITS ONT ÉTÉ RÉALISÉS AVEC L'EQUIPEMENT DE SÉRIE SUR LES DIFFÉRENTS MODÈLES DE MOTO.

Garanties et réclamations

Tous les produits SHAD sont soumis à une garantie limitée (minimum de 24 mois à compter de la date d'achat), modifiable selon la législation en vigueur de chaque pays; à condition que les produits soient

Le montage du produit SHAD sur des fixations et platines de tierces, ainsi que la modification, MODIFICATION OU RÉNOVATION de nos produits ou des éléments originaux de la moto entraînent la perte de la garantie.

Condizioni di acquisto ⁽¹⁾

Raccomandazioni

- SHAD consiglia di applicare il listino prezzi al pubblico suggerito (Suggested Retail Price) nelle sezioni pubbliche di qualsiasi sito web.
- SHAD consiglia di verificare la legislazione vigente per l'installazione di prodotti che comporti l'alterazione di qualsiasi elemento originale della motocicletta.

prodotti siano utilizzati correttamente, nel rispetto dell'uso corretto e del corretto assemblaggio indicato dal marchio. Il cliente finale ha facoltà di richiedere la garanzia del proprio prodotto, dietro presentazione di prova di acquisto (scontrino di acquisto, fattura o scontrino).

NOTA: I TEST DEI NOSTRI PRODOTTI SONO STATI EFFETTUATI SULLE DIFFERENTI MOTO E MODELLI CON EQUIPAGGIAMENTO DI SERIE.

Garanzie e reclami

Tutti i prodotti SHAD sono soggetti a una garanzia limitata per eventuali difetti di fabbricazione (minimo 24 mesi dalla data di acquisto), modificabile secondo la legislazione vigente di ogni paese; a condizione che i

L'assemblaggio del prodotto SHAD su kit di fissaggio o piastre di terzi, l'alterazione, la MODIFICA o RIFORMA dei nostri prodotti o di elementi originali della motocicletta, comportano la perdita della garanzia.

Einkaufsbedingungen

Empfehlungen

- SHAD empfiehlt die Beibehaltung unseres empfohlenen Verkaufspreises in den öffentlichen Bereichen jeder Website
- SHAD empfiehlt, die geltende Gesetzgebung für jede Installation zu überprüfen, die die Änderung eines beliebigen Originalelements des Motorrades betrifft.

die Garantie für sein Produkt zu verlangen, immer mit dem Kaufbeleg (Kaufbeleg, Rechnung oder Kassenzettel).

ANMERKUNG: ALLE TESTS UNSERER PRODUKTE WURDEN MIT DER SERIENAUSSTATTUNG DER VERSCHIEDENEN MOTORRÄDER UND MODELLE DURCHFÜHRT.

Garantien und Ansprüche

Alle SHAD-Produkte haben eine 24-monatige beschränkte Garantie, vorausgesetzt, die Produkte werden korrekt verwendet, in Übereinstimmung mit der ordnungsgemäßen Verwendung und der korrekten Montage, die von der Marke angegeben wird. Der Endkunde ist berechtigt,

Die Montage des SHAD-Produktes an Haltern oder Adapterplatten von Drittherstellern, sowie die Veränderung, Modifikation oder Umgestaltung unserer Produkte oder von Original-Elementen des Motorrades führen zum Verlust der Garantie.

Condições de Compra

Recomendações

- A SHAD recomenda manter nas secções públicas de qualquer site o nosso preço de venda ao público sugerido (Suggested Retail Price)
- A SHAD recomenda verificar a legislação vigente para qualquer instalação que suponha a alteração de qualquer elemento original da moto.

a utilização adequada e o encaixe correto indicado pela marca. O cliente final tem direito a solicitar a garantia do seu produto, sempre com o comprovativo de compra (recibo de compra, fatura ou recibo de caixa).

NOTA: TODOS OS TESTES REALIZADOS AOS NOSSOS PRODUTOS FORAM FEITOS COM O EQUIPAMENTO DE SÉRIE NAS DIFERENTES MOTOCICLETAS E MODELOS.

Garantias e reclamações

Todos os produtos SHAD têm uma garantia limitada de 24 meses, sempre que os produtos sejam utilizados corretamente, de acordo com

A montagem do produto SHAD em fixações ou grelhas de terceiros, assim como a alteração, MODIFICAÇÃO OU REFORMA dos nossos produtos ou de elementos originais da moto supõem a perda da garantia.

(1) More info at SHAD B2B
Más información en SHAD B2B
Plus d'informations sur SHAD B2B



(1) Ulteriori informazioni su SHAD B2B

SHAD TERRA

ENGINEERED FOR RIDING



MORE INFO PAG 40

	Terra Top Cases	Mounting Plate + Screws	Inner bag	Backrest
TR37 	D0TR37100	REQUIRED: D1B591PA/D1BTRPA/D1BTRPA2	X0IB47	D0RI75
TR48 	D0TR48100	REQUIRED: D1B591PA/D1BTRPA/D1BTRPA2	X0IB47	D0RI75

	Terra Side Cases	Inner bag	Inner Mesh	Lock + Key
TR36R 	D0TR36100R (right)	X0IB47	INCLUDED	INCLUDED*
TR36L 	D0TR36100L (left)	X0IB47	X0TR01	D1TRBOR
TR47R 	D0TR47100R (right)	X0IB47	INCLUDED	INCLUDED*
TR47L 	D0TR47100L (left)	X0IB47	X0TR01	D1TRBOR



* 3 cylinders for left, right and top cases + 2 keys





	Terra Saddle Bags	Description	Measurements	Price
TR40 2u. 	X0TR401	Adventure Terra Saddle Bags 64l	49,5x41,8x28,2 cm	

SHAD TERRA BLACK EDITION ALUMINIUM CASES



MORE INFO PAG 40

	Terra Top Cases	Mounting Plate + Screws	Inner bag	Backrest
TR37 BLACK EDITION 	D0TR37100B	REQUIRED: D1B591PA/D1BTRPA/D1BTRPA2	X0IB47	D0RI75
TR48 BLACK EDITION 	D0TR48100B	REQUIRED: D1B591PA/D1BTRPA/D1BTRPA2	X0IB47	D0RI75

	Terra Side Cases	Inner bag	Inner Mesh	Lock + Key
TR36R BLACK EDITION 	D0TR36100RB (right)	X0IB47	INCLUDED	INCLUDED*
TR36L BLACK EDITION 	D0TR36100LB (left)	X0IB47	X0TR01	D1TRBOR
TR47R BLACK EDITION 	D0TR47100RB (right)	X0IB47	INCLUDED	INCLUDED*
TR47L BLACK EDITION 	D0TR47100LB (left)	X0IB47	X0TR01	D1TRBOR

* 3 cylinders for left, right and top cases + 2 keys



TOP CASES SRP 2022



	Top Cases	Packs	Mounting Plate + Screws	Inner bag	Backrest	Brake Light	Upper Rack	Colour Covers
SH26		D0B26100	S INCLUDED			D0B29KL ⁽¹⁾		
SH29		D0B29100	S INCLUDED		D0RI40	D0B29KL ⁽¹⁾		D1B29E...
SH33		D0B33200	S INCLUDED		D0RI40	D0B29KL ⁽¹⁾		D1B33E8...
SH34		D0B34106 (carbon cover INCLUDED)	S INCLUDED		D0RI40	D0B29KL ⁽¹⁾		
SH37		D0B37100	S INCLUDED		D0RI60	D0B29KL ⁽¹⁾		D1B37E...
SH39		D0B39100	D0B39106 (carbon cover INCLUDED)	M INCLUDED	D0RI3900	D0B40KL ⁽¹⁾		D1B39E...
SH40		D0B40100	D0B40200 (alu look cover INCLUDED)	M INCLUDED	D0RI60	D0B40KL ⁽¹⁾		D1B40E...
SH40 CARGO		D0B40199	M INCLUDED		D0RI60	D0B40KL ⁽¹⁾		
NEW SH44		D0B44100	M INCLUDED	X0IB00	D0RI60	D0B40KL ⁽¹⁾		
SH45		D0B45100	M INCLUDED	X0IB00	D0RI60	D0B40KL ⁽¹⁾		D1B45E...
SH46		D0B46200	M INCLUDED	X0IB00	D0RI50	D0B40KL ⁽¹⁾	D0PS00	
SH47 RED		D0B47206 (carbon cover INCLUDED)	M INCLUDED	X0IB00	D0RI47	D0B40KL ⁽¹⁾		D1B47E...
SH47 WHITE		D0B47106 (carbon cover INCLUDED)	M INCLUDED	X0IB00	D0RI47	D0B40KL ⁽¹⁾		D1B47E...
SH48 DARK GREY		D0B48300	D0B48306R ⁽²⁾ B INCLUDED A OPTIONAL	X0IB00	D0RI4800	D0B29KL ⁽¹⁾	D0PS00	D1B48E...
SH48 NEW TITANIUM		D0B48400	D0B48406R ⁽²⁾ B INCLUDED A OPTIONAL	X0IB00	D0RI4800	D0B29KL ⁽¹⁾	D0PS00	D1B48E...
SH50 BACK REST INCLUDED		D0B5000	B INCLUDED A OPTIONAL	X0IB00	INCLUDED	D0B29KL ⁽¹⁾	D0PS00	D1B50E...
SH58X CARBON		D0B58206 (carbon cover INCLUDED)	B INCLUDED A OPTIONAL	X0IB10	D0RI80	D0B29KL ⁽¹⁾		D1B58E...
SH59X ALUMINIUM		D0B59200	B INCLUDED A OPTIONAL	X0IB10	D0RI80	D0B29KL ⁽¹⁾		

SIDE CASES

	Side Cases	Packs	Inner bag	Colour Covers
SH23 2 u.		D0B23100	D0B23200W (alu look cover INCLUDED)	D1B23E...
SH35 ALUMINIUM 2 u.		D0B35200	X0IB36	
SH36 2 u.		D0B36200 (carbon cover INCLUDED)	X0IB36	D1B36E...

■ 01 - Blue
 ■ 05 - Silver
 ■ 06 - Carbon
 ■ 08 - White
 ■ 09 - Red
 ■ 15 - New titanium
 ■ 17 - Dark Grey
 ■ 21 - Black
 ER - Non painted cover

⁽¹⁾ These references are not sold separately. On sale in 3 units pack.
⁽²⁾ Buying a minimum number of units

PLATES



S
Small Rack



M
Medium Rack



B
Big Rack



A
Aluminium Racks (OPTIONAL)
Aluminium Rack.- Ref. D1BTRPA
Black Aluminium Rack.- Ref. D1BTRPA2

DISPLAYS



Display	Ref.	Price
3 TOP CASES WALL DISPLAY	D0EX02	
3 TOP CASES WALL DISPLAY (SH59X/SH58X/SH50/49/48)	D0EX10	
3 TOP CASES FLOOR STAND	D0EX23	
9 TOP CASES WALL DISPLAY (SH59X/SH58X/SH50/49/48)	2 D0EX02 + 1 D0EX10 + 1 D0EX03	
9 TOP CASES WALL DISPLAY	3 D0EX02 + 1 D0EX03	
CUBE TOP CASE + 3P SYSTEM	D0EX201	
EXPANDABLE SIGN FOR CUBE (SH59X/SH58X)	D0EX58	
CUBE TERRA TOP + 4P SYSTEM	D0TR201	
TOP CASE WALL DISPLAY	D0EXTRP	
TOP CASES SLATWALL DISPLAY	D0EXTRR	
3P SYSTEM WALL DISPLAY	D0EXP4P	
4P SYSTEM WALL DISPLAY	D0EXP4P	
PIN SYSTEM FLOOR STAND	D0EXPS01	
PIN SYSTEM TABLE DISPLAY + E04P BAG	D0EXPS031	
SADDLE BAGS DISPLAY	D0EX19SR	

SPARE PARTS – TOP CASES SRP 2022



SPARE PARTS- CASES

Top Cases	Mounting Plate	Mounting Plate Screws	Reflector	Locking System	Lock Kit Keys	Lid Stop Strap
SH26	D1B29PAR	D1BABOR	D1B261CAR	D1B29MAR	201722R	D1B1TIR
SH29	D1B29PAR	D1BABOR	D1B291CAR	D1B29MAR	201722R	D1B1TIR
SH33	D1B29PAR	D1BABOR	D1B331CAR	D1B341MAR	201722R	D1B1TIR
SH34	D1B29PAR	D1BABOR	D1B341CAR ⁽¹⁾ D1B342CAR ⁽²⁾	D1B341MAR	201722R	D1B1TIR
SH37	D1B37PAR	D1B37BOR	D1B371CAPR	D1B37MAR	201722R	D1B1TIR
SH39	D1B40PAR	D1B40BOR	D1B39CAR	D1B391MAR	201722R	D1B1TIR
SH40 CARGO	D1B40PAR	D1B40BOR	D1B401CAR D1B403CAR(alu look)	D1B45MAR	201722R	D1B1TIR
SH44	D1B40PAR	D1B40BOR	D1B441CAR	D1B44MAR	201722R	D1B1TIR
SH45	D1B40PAR	D1B40BOR	D1B451CAR	D1B45MAR	201722R	D1B1TIR
SH46	D1B40PAR	D1B40BOR	D1B465CAR	D1B46MAR	201722R	D1B1TIR
SH47	D1B40PAR	D1B40BOR	D1B47CAR (white) D1B471CAR (red)	D1B47MAR	201722R	D1B1TIR
SH48 DARK GREY	D1B59PAR	D1B40BOR	D1B48CAR	D1B481MAR ⁽³⁾ D1B481PMAR ⁽⁴⁾	201896R ⁽³⁾ 203076R ⁽⁴⁾	D1B1TIR
SH48 NEW TITANIUM	D1B59PAR	D1B40BOR	D1B48CAR	D1B482MAR ⁽³⁾ D1B482PMAR ⁽⁴⁾	201896R ⁽³⁾ 203076R ⁽⁴⁾	D1B1TIR
SH50	D1B59PAR	D1B40BOR	D1B50CAR	D1B50MAR	201896R	D1B1TIR
SH58X	D1B59PAR	D1B40BOR	D1B58CAR	D1B59MAR ⁽³⁾ D1B59PMAR ⁽⁴⁾	201896R ⁽³⁾ 203076R ⁽⁴⁾	D1B6TIR
SH59X	D1B59PAR	D1B40BOR	D1B59CAR	D1B59MAR ⁽³⁾ D1B59PMAR ⁽⁴⁾	201896R ⁽³⁾ 203076R ⁽⁴⁾	D1B6TIR
TR37				D1TRTSR(upper part) D1TR37MIR(lower part)	D1TRB01R	D1B6TIR
TR48				D1TRTSR(upper part) D1TR48MIR(lower part)	D1TRB01R	D1B6TIR

Hinge	Stickers	Box Seal Gasket	Cargo Strap	Side Band	Rubber Stoppers	Others
201775R						
201775R	D1B291ETR					
201775R	D1B332ETR					
201775R	501588R					D1B34E06 (carbon cover)
201121R		400271R				
201121R	D1B39ETR				202546R	
201121R	D1B401ETR 501910R(alu look)	400271R			202546R	D1B40PTR (Upper Rack) D1B40E25(cover alu look)
200784R	D1B44ETR	202467_4R			202546R	
201121R	D1B451ETR	400271R	D1B45CGR		202546R	
201121R	D1B461ETR	400271R	D1B46CGR		202546R	
200784R	D1B47ETR	202467_3R				D1B47E06 (carbon cover)
200784R	D1B481ETR	400341_5R	D1B48CGR	D1B481EMR	200799R	
200784R	D1B482ETR	400341_5R	D1B48CGR	D1B482EMR	200799R	
200784R		203062R	D1B50CGR	D1B50EMR	200799R	D0RI70(backrest)
200784R	D1B58ETR	203062R	D1B59CGR	D1B59EMR	200799R	D1B59MEALR (Expandable system) D1B58E06(carbon cover)
200784R	D1B59ETR	203062R	D1B59CGR	D1B59EMR	200799R	D1B59MEALR(Expandable system) D1B59T0R (cover)
		203507R				X0TR02R (inner mat) 203471R (alu cover) 203471RB(black alu cover)
		203507R				X0TR02R (inner mat) 203471R (alu cover) 203471RB(black alu cover)

SPARE PARTS – SIDE CASES

SH23			D1B23CAR D1B231CAR (alu look)	D1B23MAR	*200062R	D1B5TIR
SH35				D1B362MAR ⁽⁴⁾	*200062R ⁽³⁾ *203134R ⁽⁴⁾ *203134R1 ⁽⁵⁾	D1B5TIR
SH36			D1B36CAR ⁽³⁾ D1B361CAR ⁽⁴⁾	D1B362MAR ⁽⁴⁾	*200062R ⁽³⁾ *203134R ⁽⁴⁾ *203134R1 ⁽⁵⁾	D1B5TIR
TR36				D1TRTSR (upper part) D1TR36MIR (lower part)	D1TRBOR	
TR47				D1TRTSR (upper part) D1TR47MIR (lower part)	D1TRBOR	

201775R	501720R 501909R (alu look)				D1B23GOR	D1B23FIR (fitting bracket) D1B23E25 (cover alu look)
200784R		400341_8R	D1B36CGR			D1B3613PR (fitting bracket) D1B35TLR (left side lid) D1B35TRR (right side lid)
200784R	501424R	400341_8R	D1B36CGR			D1B3613PR (fitting bracket) D1B36E06 (carbon cover)
		203507R				D1TR361PR (fitting bracket) 203163R (alu cover) 203163RB (black alu cover)
		203507R				D1TR361PR (fitting bracket) 203163R (alu cover) 203163RB (black alu cover)

⁽¹⁾ Top cases with colour Cover
⁽²⁾ Top cases without colour Cover

⁽³⁾ Red key
⁽⁴⁾ Black key

⁽⁵⁾ Use 1 key with top + side case, red key
* Includes 3 lock cylinders and keys for top and side cases

FITTING KITS SRP 2022

Top fitting
Top Case



Make, model and year	Ref.	Plate	Price	Ref.	Price	Ref.	Price	Ref.	Ref.	Price	Ref.	Size	Price
HYUNDAI													
GV 125 AQUILA (18-22)	NADTN ⁽¹⁾	S/B		H0GV18IF ⁽³⁾							H0GV18SN		
	NADTNN ⁽²⁾	S/B											
KAWASAKI													
J125 (16-17) / J300 (13-22)	K0J334ST	S/B									K0J334RV ⁽⁴⁾		
Z125 (19-22)	K0Z119ST	S/B											
Z300 (14-17)					X025PS								
VERSYS-X 300 (17-22)	K0VR37ST	U		K0VR37IF	X025PS								
NINJA 400 (18-22)					X025PS								
Z400 (19-22)	K0Z449ST	S/B			X025PS								
ER5 500 (02-07)	K0ER57ST	S/B								D0SS5SE			
ZX-6R (09-12)					X014PS								
ER6 N-F 650 (05-08)	K0ER65ST	S/B			X014PS								
ER6 N-F 650 (09-11)	K0ER69ST	B			X014PS								
ER6 N/6F (12-17)	K0ER62ST	B		K0ER62IF ⁽³⁾	X014PS					D0SS5SE			
NINJA 650 (17-22)	K0Z667ST	B		K0Z667IF	X025PS					K0Z667SE			
VERSYS 650 (07-09)	K0VR67ST	S/B											
VERSYS 650 (10-14)	K0VR60ST	B		K0VR60IF ⁽³⁾	X014PS					D0SS5SE			
VERSYS 650 (15-22)	K0VR65ST	B/A		K0VR65IF ⁽⁶⁾	X014PS								
VULCAN S 650 (15-22)	NADTN ⁽¹⁾	S/B		K0VL65IF	X014PS						K0VL65SN		
	NADTNN ⁽²⁾	S/B											
Z650 (16-22)	K0Z667ST	B		K0Z667IF	X025PS					K0Z667SE			
										K0Z667SR			
Z750/R (07-12)	K0Z778ST	B			X014PS								
	K0Z778CL SR	S/B											
ZR-7/S (01-05)	K0ZR71ST	S/B											
Z900 (17-22)	K0Z997ST	B/A		K0Z997IF	X025PS					K0Z997SE			
										K0Z997SR			
Z900RS (18-22) / Z900RS CAFÉ (20-22)	K0ZR98ST	B		K0ZR98IF	X014PS								
H2-SX (15-22)					X014PS								
KLV 1000 (05-07)	S0VS12ST	S/B											
Z 1000 (07-09)	K0Z778ST	B											
	K0Z778CL SR	S/B											
Z 1000 (10-13)					X014PS								
Z 1000 SX (11-17)	K0ZS11ST	B		K0ZS16IF (15-16)	X014PS								
Z 1000 SX (16) (18-20)	K0ZS18ST	B			X014PS								
NINJA 1000 SX (21-22)	K0ZS18ST	B			X025PS								
ZX-10R (10-12)					X014PS								
ZX-10R (2018)					X014PS								
VERSYS 1000 (12-18)	K0GT18ST	S/B		K0VR16IF ⁽³⁾ (15-18)	X014PS								
VERSYS 1000/S/SE (19-22)	K0GT18ST	S/B		K0VR19IF ⁽³⁾	X025PS								
GTR 1400 / CONCOURS 1400 (07-17)	K0GT18ST	S/B			X014PS								
ZZR 1400 (02-17)					X014PS								
ZX-14R (2018)					X014PS								
KEEWAY													
CITY BLADE 125 (15-17)	K0CT15ST	S/B											
K-LIGHT 125 (18-21)	NADTN ⁽¹⁾	S/B									K0KL18SN		
	NADTNN ⁽²⁾	S/B											
SUPERLIGHT 125 (11-21)	NADTN ⁽¹⁾	S/B									K0SP12SN		
	NADTNN ⁽²⁾	S/B											
RKS 125/150/200/200S (11-21)	K0RS11ST	S/B			X022PS								
RKV 125/150/200S/200S FACTORY (11-21)	K0RK11ST	S/B			X022PS								
RKR 125 (17-21)					X022PS								
RKF 125 (17-21)	K0RK18ST	B/A			X022PS (only E10P/E16P)								
SILVER BLADE 125 (12-17)	K0SL12ST	S/B											
ZAHARA 125 (21-22)	K0ZH11ST ⁽⁷⁾	B											
VIESTE 125/300 (20-22)	K0VS10ST	S/B											
BLACKSTER 250 (15-22)	NADTN ⁽¹⁾	S/B									K0SP12SN		
	NADTNN ⁽²⁾	S/B											
KTM													
DUKE 125 (11-16) / 200 (11-21)	K0DK34ST	S/B			X016PS						K0DK34SE		
					X021PS (only E10P/E16P)						K0DK17SE		
DUKE 125 (17-21)	K0DK17ST	S/B											
DUKE 390 (11-16)	K0DK34ST	S/B			X016PS								

Bike compatibility



Top fitting
Top Case



Make, model and year	Ref.	Plate	Price	Ref.	Price	Ref.	Price	Ref.	Ref.	Price	Ref.	Size	Price	
DUKE 250/390 (17-21)	K0DK17ST	S/B									X021PS			
DUKE 390 ADVENTURE (21-22)	K0DK30ST	U									K0DK17SE			
RC 390 (14-16)											K0DK30SE			
RC 390 (17-19)											X016PS			
											X016PS			
790 ADVENTURE / 790 R (19-20)	K0DV17ST	U									K0DV79IF			
											K0DV794P			
890 ADVENTURE L/R/RALLY (21-22)	K0DV17ST	U									K0DV79IF			
											K0DV794P			
ADVENTURE 1050 (14-16)	K0DV17ST	U									K0DV17IF			
											K0SP194P			
ADVENTURE 1090 R/CLASSIC (14-19)	K0DV17ST	U									K0DV17IF (17-19)	X017PS (17-19)		
											K0SP194P			
ADVENTURE 1190 / R (14-16)	K0DV17ST	U									K0DV17IF	X017PS		
											K0SP194P			
SUPER ADVENTURE 1290 R/S/T (14-20)	K0DV17ST	U									K0DV17IF	X017PS (17-19)		
											K0SP194P			
SUPER ADVENTURE 1290 R/S/T (21-22)	K0DV11ST	U									K0DV114P	X0172PS		
1290 SUPERDUKE R (13-20)												X017PS		
KYMCO														
AGILITY 50/125 RS (10-22)	K0GL51ST	S/B												
VITALITY 2T 50 (09-14)	K0VT53ST	S/B												
PEOPLE 125 S (18-22)	K0PP18ST	S/B										K0PP18SC	5	
AGILITY CITY/AGILITY 16 + 50 /125i/ 200i 2T/4Ti (14-22)	K0GL14ST	S/B										K0GL10SC	5	
AGILITY CITY 125 (16-22)														
G - DINK 125i / 150i/ 300 (12-16)	K0GD12ST	S/B												
FILLY 125 ABS (18-22)	K0FL18ST	S/B												
LIKE 125 (15-16)	K0LK15ST	S/B												
LIKE 125 (17-20)	K0LK17ST	S/B												
MILLER 125 (21-22)													K0ML11SC	5
SUPER DINK/DOWNTOWN/DINK STREET 125-300 (09-15)	K0SP19ST	S/B											K0SP19RV ⁽⁴⁾	
	K0SP19KT ⁽⁵⁾	S/B												
SUPER DINK/DOWNTOWN 125-350 (16-22)	K0DW15ST	S/B											K0DW15RV ⁽⁴⁾	
													K0SP39SC	7
SUPER 8 50/125/150 (21-22)	K0SP51ST ⁽⁷⁾													
PULSAR 125 (11-15)														
X-TOWN (16-21) / GRAND DINK 125/300 (16-21)	K0GD16ST	S/B											K0GD16RV ⁽⁴⁾	
X-TOWN CITY 125/300 / X-TOWN 125/300 / X-TOWN CT 125/300 (22)	K0XT11ST	U											K0XT11SC	5
XCITING 250/500 (05-11)	K0XC55ST	S/B												
K-XCT 125/ 300i (13-17)	K0XC32ST	S/B												
AGILITY 300 R16 (19-21)	K0GL39ST													
G-DINK 300i (18-22)													K0GD38RV ⁽⁴⁾	
XCITING 400 (13-17)	K0XC42ST	S/B												
XCITING 400S (18-22)	K0XC48ST	U											K0XC48RV ⁽⁴⁾	
XCITING 500 ABS (05-12) /500i R (10-15)	K0XC55ST	S/B											K0XC41SC	5
AK 550 (17-22)	K0AK57ST	S/B											K0AK57RV ⁽⁴⁾	
MASH														
SEVENTY-FIVE (17-20)													M0SV17SR	
MOTO GUZZI														
V85 (19-22)	M0VT89ST	B/A												

FITTING KITS SRP 2022

Top fitting

Top Case



Make, model and year	Ref.	Plate	Price	Ref.	Price	Ref.	Price	Ref.	Ref.	Price	Ref.	Size	Price
PEUGEOT													
KISBEE/RS 50 (13- 20 / KISBEE 100 (14-22)	P0KS53ST	S											
VIVACITY 50 / 100 (09-07)	P0V59T	S/B											
ELYSTAR 50/ 125/ 150 (02-12)	P0LS52ST	S/B											
CITYSTAR 125/ 200 i (12-22 / CITYSTAR 50 (13-22)	P0CT16ST	S/B											
PULSION 125 RS/125 ACTIVE/125 ALLURE (18-22)	P0PL19ST	U											
METROPOLIS 400i (21-22)											P0MT41SC	7	
PIAGGIO													
ENERGY NRG 50 (05-22)	V0NR55ST	S/B											
LX 50/125 (05-08)	V0LX55ST	S/B											
LIBERTY 50/125 (05-14)	V0LB19ST	S/B											
LIBERTY 50/125 (15-22)	V0LB19ST	S/B									V0LB15SC	3	
PRIMAVERA 50 /125 (14-22)											V0PR19SC	5	
TYPHOON 50/125 (11-22)	V0TH11ST	S/B											
ZIP 50/125 (09-14)	V0ZP59ST	S/B											
MEDLEY 125 (16-22)	V0MD16ST	S/B											
BEVERLY TOURER 125/250/400 (08-22)	V0TR18ST	S/B											
BEVERLY 125ie / 300 ie TOURER/ tourer sport 330(13) (11-22)	V0TR18ST	S/B											
FLY 50/125/150 (05-12)	V0FL15ST	S/B											
FLY 50/125/150 (13-14)	V0FL13ST	S											
VESPA GTS SUPER 125/300 (19-22)	V0GT39ST	S/B											
X10 (12-22)	V0X112ST	S/B											
MP3 125RL/300/400/500 LT-SPORT-HYBRID 125/300 LT (07-22)	V0MP10ST	B/A											
MP3 125/500 SPORT BUSINESS (14-17)	V0MP54ST	S/B											
MP3 300/350/500 BUSINESS LT/SPORT (18-22)	V0MP58ST	S/B											
MP3 125/300 YOURBAN (11-18)	V0YR11ST	S/B									V0YR11RV ⁽⁴⁾		
BEVERLY SPORTOURING 350i (18-21)	V0TR18ST	S/B											
BEVERLY 300/400/300S/400S (21-22)	V0BV41ST ⁽⁵⁾	S/B									V0BV41RV ⁽⁴⁾	V0BV41SC	5
MP3 300 YOURBAN 300/ YOURBAN SPORT 300 / 300 HPE / 300 HPE SPORT (11-22)	V0YR11ST	S/B									V0YR11RV ⁽⁴⁾		
QUADRO													
3D 350 (12-16)	Q03D32ST	S/B											
3D 350 S (13-22)	Q03S34ST	S/B											
ROYAL ENFIELD													
HIMALAYAN 410 (18-20)	R0HM49ST	S/B									R0HM49IF		
HIMALAYAN 410 (21-22)	R0HM41ST	U									R0HM49IF		
INTERCEPTOR 650 (19-22)											R0NT69SR		
SILENCE													
S01 (20-22)	S0SL10ST ⁽⁵⁾	S/B											
SUPER SOCO													
CPX (20-22)	S0CP10ST	S/B											
CUX (19-22)	S0CX19ST ⁽⁵⁾	S/B											
TC/MAX (19-22)	S0TC11ST	S											
SUZUKI													
BURGMAN 125/150 (02-06)	S0BR12ST	S/B											
BURGMAN 125/200 (07-21)	S0BR17ST	S/B											
GSX-S 125 (17-19)/ GSX 150 R/S (17-21)	S0GS17ST	S/B									S0GS17IF	X013PS	
INAZUMA 250 (13-21)	S0NZ23ST	S/B										X013PS	
BURGMAN 250/ BUSINESS (01-09)	S0S21T	S/B										X013PS	
GSX-S 250 (17-21)												X013PS	
V-STROM 250 (17-21)	S0VS27ST	S/B									S0VS27IF	X013PS	
BURGMAN 400 (01-06)	S0S21T	S/B											
BURGMAN 400 K7 (06)	S0BR46ST	S/B											
BURGMAN 400 (07-09)	S0BR46ST	S/B											
BURGMAN 400 Z (07) remove original backrest	S0BR46ST	S/B											
BURGMAN 400 ABS (10-16)	S0BR46ST	S/B											
BURGMAN 400 (17-22)	S0BR47ST	S/B											
GS 500 E (89-00)	S0G54T	B/A											
GS 500 (2003)												X013PS	
GS 500 / GS 500 F (01-11)	S0GS51ST	B/A										X013PS	
GSX 600 F (98-04)	S0G78T	S/B										X013PS	
GSX-R 600 / 750 (06-10)												X020PS	

Bike compatibility



Top fitting

Top Case



Make, model and year	Ref.	Plate	Price	Ref.	Price	Ref.	Price	Ref.	Ref.	Price	Ref.	Size	Price	
BANDIT GSF 600 N (94-99)	S0B64T	B/A												
BANDIT GSF 600 (00-05)	S0BN60ST	B										X013PS		
BANDIT GSF 650/S (09-15)												X013PS		
BANDIT 650 N/S GSX 650 (04-17)	S0BN69ST	B									S0BN61IF ⁽³⁾	X013PS		
BANDIT GSX 650 F (08-17)	S0BN69ST	B									S0BN61IF ⁽³⁾	X013PS	D0SS5SE	
BANDIT 650 S ABS (11-17)	S0BN69ST	B									S0BN61IF ⁽³⁾	X013PS		
BURGMAN 650 (02-14)	S0BR62ST	S/B												
BURGMAN 650 EXECUTIVE (04-21)	S0BR62ST	S/B												
DR 650 RSE (01-96)	DIRECT ASSEMBLY ON MOTORCYCLE													
V-STROM DL 650 (04-11)	S0VS12ST	S/B									S0VS62IF ⁽³⁾	X020PS		
V-STROM 650 (12-16)	S0VS62ST	S/B									S0VS63IF	X013PS	S0VS62SE	
V-STROM 650/XT (17-22)	S0VS14ST	U									S0VS61IF	X013PS		
SV 650 (09-02)	S0SV69ST	B									S0VS694P			
SV 650 / S (03-08)												X013PS		
SV 650 ABS (16-17)	S0SV68ST	B									S0SV68IF ⁽³⁾	X013PS	D0SS5SE	
SV 650 / SV 650 X (18-22)	S0SV68ST	B									S0SV68IF ⁽³⁾	X013PS		
GSX 650 F (11)	S0BN69ST	B									S0BN61IF ⁽³⁾	X013PS		
GLADIUS 650 (09-16)	S0GL69ST	B										X013PS		
GSR 750 (11-17)	S0GS71ST	B										X013PS (11-16)	S0GS71SE	
BANDIT 750 (96-97)	S0B64T	B/A												
GSX 750 F (98-02)	S0G78T	B/A												
GSX-S 750 (17-21)	S0GS77ST	B										X013PS	S0GR77SE	
GSX-R 1000 (09-17)												X013PS		
GSX-S 1000/ GSX-S 1000F (15-17)												X013PS		
KATANA 1000 (19-21)	S0KT19ST	B									S0KT19IF	X013PS		
V-STROM DL 1000 (02-13)	S0VS12ST	S/B												
V-STROM DL 1000 (14-19)	S0VS14ST	U									S0VS10IF	X013PS	S0VS14SE	
											S0VS104P			
V-STROM 1050/XT (20-22)	S0VS14ST	U									S0VS10IF			
											S0VS104P			
BANDIT 1200 N/S (96-00)	S0B64T	B/A												
BANDIT 1200 / N/S (01-04)	S0BN60ST	B												
BANDIT GSF 1200 /S (05-14)	S0BN69ST	B										X013PS		
BANDIT GSX 1250 N/FA (11-17)	S0BN69ST	B										X013PS		
BANDIT GSF 1250 (07-09)	S0BN69ST	B										X013PS		
GSX 1250F (10-16)												X013PS		
GSX 1300 R HAYABUSA (08-17)												X013PS		
SYM														
CRUISYM 125/300 (18-22)	S0CR38ST	S/B											S0CR38RV ⁽⁴⁾	
FIDDLE 125 (21-22)													S0FD11SC	5
JET14 125/200 (17-22)	S0JT17ST	S/B												
JET X 125 (21-22)	S0JT17ST	S/B												
GTS 125 / 250 (06-11)	S0GT25ST	S/B												
GTS 125 / 250/ 300 EVO - EVO Fi (10-17)	S0GT25ST	S/B												
JOYMAX GTS 125/ 125i /250i /300i/ Evo (13-20)	S0JM13ST	S/B											S0CR38RV ⁽⁴⁾	
GTS 300i (13-21)	S0JM13ST	S/B												
JOYMAX Z+ 125/300 (21-22)	S0CR38ST	S/B											S0CR38RV ⁽⁴⁾	
SYMPHONY ST 50 (18) / ST125 (15-20) /ST 200 ABS (18-22)	S0SM15ST	S/B											S0SM10SC	3
SYMPHONY 50/125 S-LX-SR (09-14)													S0SM11SC	3
SYMPHONY 50/125 S-LX-SR (15-22)	S0SM15ST	S/B											S0SM11SC	3
SYMPHONY ST125 (21-22)	S0SM15ST	S/B											S0SY11SC	3
HD 300 (19-21)	S0HD39ST	S/B												
MAXSYM 400/600 ABS (11-20)	S0MX46ST	S/B												
MAXSYM 400 (21-22)	S0MS41ST	U											S0MS41RV ⁽⁴⁾	
MAXSYM 500 TL (20-22)	S0MX50ST	U											S0MX50RV ⁽⁴⁾	
TRIUMPH														
STREET TRIPLE 675/R (07-12)	</													

FITTING KITS SRP 2022

Top fitting

Top Case

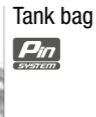

Make, model and year	Ref.	Plate	Price	Ref.	Price	Ref.	Price	Ref.	Ref.	Price	Ref.	Size	Price
TIGER 900/GT/RALLY/PRO (20-22)	T0TG90ST	U		T0TG904P		X0182PS							
BONNEVILLE T100 900 (18-22)											T0BN97SR		
STREET SCRAMBLER 900 (18-22)											T0ST98SR		
SPEED TRIPLE 1050 (08-17)						X0182PS							
SPRING GT 1050 (10)						X0182PS							
SPRINT GT 1050 (11-13)						X0182PS							
SPRINT GT 1050 (14-16)						X0182PS							
SPRING ST 1050 (05-11)						X0182PS							
TIGER 1050 (07-12)						X0182PS							
TIGER SPORT 1050 (15-21)	T0TG16ST	S/B		T0TG16IF		X0182PS (13-19)							
TIGER EXPLORER 1200 (12-15)	DIRECT ASSEMBLY WITH BOTTOM RACK					X0182PS							
TIGER EXPLORER 1200 (2016)						X0182PS							
TIGER EXPLORER 1200 (17-21)	T0XP16ST	S/B		T0XP16IF		X0182PS							
UM													
CHILL 125 (19-22)	U0CH59ST												
RENEGADE SCRAMBLER 125 (18-22)						X0182PS							
RENEGADE COMANDO/SPORTS S/VEGAS (19-22)	U0RN19ST			U0RN19IF									
SCRAMBLER (17-22)	U0DV18ST			U0DV18IF									
SCRAMBLER CLASSIC/SPORT (17-22)	U0SC18ST												
DSR ADVENTURE 125 EF/TT (18-22)	U0DV18ST			U0DV18IF		X0182PS							
VOGE													
AC300 (20-22)	V0AC30ST	S		V0AC30IF				D0SS5SE					
300R(20-22)	V0VR30ST	U		V0VR30IF				D0SS5SE					
500DS (20-22) /500DSX (21-22)	V0DS50ST	U		V0DS50IF									
500R(20-22)	V0VR50ST ⁽⁵⁾	S/B						D0SS5SE					
650DS(21-22)	V0DS61ST	B		V0DS61IF									
650DSX (21-22)	V0DX61ST	B		V0DS61IF									
	V0DS61ST	B		V0DS614P									
YAMAHA													
NEO'S 50 / 100 (97-07)	Y0N10T	S											
NEO'S 50/ 125 / 4 TEMPI (08-22)	Y0NS58ST	S/B											
AEROX 50/100 (97-08)	Y0A57T	S											
AEROX 50 (13-20) / AEROX 4 (21-22)	Y0RX53ST	S											
WHY 50 (08-13)	DIRECT ASSEMBLY ON MOTORCYCLE												
JOG II 50 (02 -19)	Y0JG52ST	S/B											
CYGNUS X 125 (04-06)	Y0CY14ST	S/B											
CYGNUS X 125 (07-16)	Y0CY17ST	S/B											
DELIGHT 115 (13-18)	Y0DL53ST	S/B											
DELIGHT 125 (17-22)	Y0DL17ST	S/B											
TRICITY 125 (14-22)	Y0TR14ST	S/B											
YBR 125 i / CLASSIC SP (10-22)	DIRECT ASSEMBLY ON MOTORCYCLE												
MAJESTY S 125 (14-17)	Y0MJ15ST	S/B											
YS 125 (17-21)	Y0YS17ST	S/B											
X-MAX 125 -250 (05-09)	Y0XM25ST	S/B											
X-MAX 125-250 (10-13)	Y0XM20ST	S/B											
X-MAX 125 (17-20)	Y0XM37ST	U					Y0XM37RV ⁽¹⁾	Y0XM11SC				7	
X-MAX 125 (21)	Y0XM11ST	U					Y0XM37RV ⁽¹⁾	Y0XM11SC				7	
X-MAX 125i (14-16) /250(14-17)	Y0XM43ST	S/B											
N MAX 125i (15-20)	Y0NM15ST	S/B											
N MAX 125i (21)	Y0NM11ST ⁽⁵⁾	S/B						Y0NM11SC				3	
FZ 2.0 (15-20)	Y0FZ26ST	S/B		Y0FZ26IF									
TRICITY 300 (20-22)	Y0TR30ST	U					Y0XM37RV ⁽¹⁾	Y0XM11SC				7	
X-MAX 300 (17-21)	Y0XM37ST	U					Y0XM37RV ⁽¹⁾	Y0XM11SC				7	
MT-03 (06-14)						X011PS							
MT-03 (15-20)	Y0MT36ST	S/B		Y0MT36IF		X011PS		D0SS5SE					
MT-03 (21)	Y0MT31ST	U		Y0MT31IF									
YZF R3 (15-17)						X011PS							
R3 (2017)						X011PS							
MAJESTY 400 (04-06)	Y0MJ44ST	S/B											
MAJESTY YP 400 (10-13)	Y0MJ44ST	S/B											
X-MAX 400 (16-17)	Y0XM43ST	S/B											
X-MAX 400 (17-21)	Y0XM37ST	U					Y0XM37RV ⁽¹⁾	Y0XM11SC				7	
T-MAX XP500 (01-07)	Y0T51T	S/B											
T-MAX XP500 / ABS (08-12)	Y0TM59ST	S/B					Y0TM52RV ⁽¹⁾						
T-MAX 530 (12-16)	Y0TM52ST	S/B					Y0TM52RV ⁽¹⁾						
T-MAX 530/SX SPORT/DX (17-20)	Y0TM57ST	U											
T-MAX 560 (20-21)	Y0TM57ST	U											
DIVERSION XJ 600 NS/F ABS (09-16)	Y0XJ69ST	B/A				X011PS							

Bike compatibility





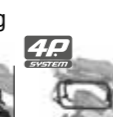

Top fitting

Top Case











Make, model and year	Ref.	Plate	Price	Ref.	Price	Ref.	Price	Ref.	Ref.	Price	Ref.	Size	Price
XT 660 X/R (04-16)	Y0XT64ST	S/B											
XT 660 Z TENERE (08-16)											X011PS		
FAZER 600 (98-00)	Y0F68T	B/A											
FAZER 600 (01-03)	Y0FZ61ST	B/A											
FAZER FZ6 N/S 600 (04-06)	Y0FZ64ST	S/B									X011PS		
FAZER FZ6 N/S 600 (07-11)	Y0FZ64ST	S/B									X011PS		
FAZER FZ6 N/S 600 (2012)	Y0FZ64ST	S/B											
FZ6R R (2017)											X011PS		
YZF R6 (06-18)											X011PS		
MT07 (14-21)	Y0MT78ST	S/B		Y0MT78IF		X012PS		Y0MT78SE			Y0MT71SR		
TENERE 700 (19-22)	Y0TN79ST	B/A		Y0TN794P									
TRACER 700 (16-20)	Y0MT76ST	B		Y0MT76IF		X011PS		D0SS5SE					
				Y0MT714P									
TRACER 7 (21-22)	Y0MT76ST	B		Y0MT76IF		X011PS		D0SS5SE					
				Y0MT714P									
TRACER 700 GT (19-22)	Y0TR79ST	B				X011PS							
FZ07 (15-17)						X011PS							
XSR 700 (16-22)											Y0XS77SR		
FAZER FZ8 800 (10-15)	Y0FZ84ST	S/B				X011PS		Y0FZ80SE					
FAZER FZ8 800 (2016)	Y0FZ84ST	S/B						Y0FZ80SE					
TDM 900 (2014)											X011PS		
DIVERSION XJ 900 SN (94-03)	Y0XJ94ST	B											
FJ09 (15-17)											X012PS		
MT09/STREET RALLY/FZ09 (13 -16)	Y0MT93ST	B				X011PS		Y0MT97SE					
MT09 /FZ09 (17-21)	Y0MT97ST	B		Y0MT97IF		X011PS		Y0MT97SE					
MT09 SP (18-21)	Y0MT97ST	B		Y0MT98IF		X011PS							
MT09/SP (21)	Y0MT91ST	U		Y0MT91IF		X011PS		Y0MT91SE			Y0MT91SR ⁽⁷⁾		
NIKEN 900 (18-22)	Y0NK98ST	S/B		Y0NK98IF ⁽³⁾		X011PS							
TRACER 900 (15-17)	Y0MT95ST	B		Y0MT95IF		X012PS							
				Y0TC98IF ⁽³⁾									
TRACER 900 /GT (18-20)	Y0TC98ST	U		Y0TR984P		X012PS		Y0TR98SE					
TRACER 9/GT (21-22)	*Y0TR91ST	U		Y0TR91IF ⁽³⁾		X012PS		Y0TR91SE					
	Y0TC91ST	U											
XSR 900 (16-22)						X011PS							
MT10 / FZ10 (16-21)	Y0MT16ST	S/B		Y0MT16IF ⁽³⁾		X011PS							
FAZER 1000 (01-05)	Y0FZ11ST	B/A											
FAZER 1000 (06-14)						X011PS							
FAZER 1000 - FZ1 (06-15)	Y0FZ16ST	B				X011PS							
FAZER 1000 - FZ1 (16)	Y0FZ16ST	B											
YZF - R1 1000 (09-12)						X011PS							
YZF - R1 1000 (15-18)						X011PS							
XT 1200 Z SUPER TENERE 1200 (10-22)	Y0XT10ST	B/A				X011PS							

SPORT BAGS

	Ref.	Description	Measurements	Price	Qty x masterbox
	E04	X0SE04	Semi rigid small tank bag	3L / 29 26x10 cm	10
	E22	X0SE22	Semi rigid tank bag	16-22L / 42x30x22 cm	5
	NEW E48 2U.	X0SE481	Semi rigid saddle bags	46-58L / 47x24/30x29 cm	4
	NEW E48SR 2U.	X0SE48SR	Hard shell saddle bags	30L / 45x27x29 cm	1

TOURING BAGS



	Ref.	Description	Measurements	Price	Qty x masterbox
	SL58 2U	X0SL58	Big saddle bags	46-58 L / 18-25x47x29cm	2
	SL20F	X0SL20F	Tank bag -straps fastener	15-20 L / 18-21x30x40cm	4
	SL12M	X0SL12M	Small tank bag-magnets	4 L / 10x30x19cm	15
	SL86	X0SL86	Backpack bag	26 L / 27x30x45cm	5
	SL05	X0SL05	Big leg bag	2 L / 11x25x15cm	32
	SL04	X0SL04	Small leg bag	0,5 L / 3x26x13cm	80
	SL03	X0SL03	Waist bag	3 L / 9x23x16cm	20
	SL01	X0SL01	Toll pass pouch	4x6x10cm	200
	SC25	X0SC25	Scooter bag	25 L / 38x26x27 cm	10

Ref.	Accessories For Soft Bags: Description	Price	Qty x box
X1SB11	Magnets (2 u.): SB25, SB22, SB15		-
X1SL11	Magnets (4 u.): SL35/SL23/SL20/SL12		40
X1SB97	Thermo Pad E48/SL58/SB50/SB60		25
X1SL90	Universal Base Tank: SL35/SL23/SL20/SL12		45

Ref.	Accessories For Soft Bags: Description	Price	Qty x box
X1SL09	Straps for Tank Bag		-
X1SL01	Rain cover for small tank bags		100
X1SL02	Film protector		-
X0IB08	Small Duffle Bag		50







* until stock ends

PIN SYSTEMS BAGS



	Ref.	Description	Litres / Mesures	Price	Qty x masterbox
	E04P	X0SE04P	Semi rigid pin system tank bag	3L / 29x26x10 cm	12
	E10P	X0SE10P	Semi rigid pin system tank bag	5L / 31x22x15 cm	8
	E16P	X0SE16P	Semi rigid pin system tank bag	11 to 15L / 28x40x20/26 cm	4

ADVENTURE BAGS

100% **WATERPROOF**

	Ref.	Description	Measurements	Price	Qty x masterbox
	SW22	X0SW22	Tank Bag	13L / 37x19x17	10
	SW23	X0SW23B	Tank Bag	14L / 35x26x24	4
	SW38	X0SW38	Rear duffle bag	35L / 54x28	15
	SW42 2U.	X0SW42	Saddle bags	50L / 42x34x17	3
	SW45	X0SW45	Rear backpack	40L / 48x31x17	10
	IB20	X0IB20	Duffle Bag	20L / 54x24x3	25

CAFE RACER BAGS

	Ref.	Description	Measurements	Price	Qty x masterbox
	SR18	X0SR18	Tank Bag	8L / 36x18x15 cm	9
	SR28	X0SR28	Rear bag	27L / 40x26x25 cm	4
	SR38 1U.	X0SR38	Saddle bag	10L / 34x15x24 cm	6

BACKRESTS

Colour	Ref.	Price	Colour	Ref.	Price	Colour	Ref.	Price	Colour	Ref.	Price
Black	D0RP00		Grey	D0RP05		White	D0RP08		Black	D0RP00N	



SPECIFIC BACKREST SUPPORT SOLD SEPARATELY

RAIN JACKETS SRP 2022

Size	Cm	Ref.	Price	Qty x masterbox
S	57	X0SR55S		40
M	59,5	X0SR55M		
L	62	X0SR55L		
XL	64,5	X0SR55XL		
XXL	67	X0SR55XXL		
3XL	69,5	X0SR553XL		



RAIN PANTS

Size	Cm	Ref.	Price	Qty x masterbox
S	34	X0SR20S		40
M	36,5	X0SR20M		
L	39	X0SR20L		
XL	41,5	X0SR20XL		
XXL	44	X0SR20XXL		
3XL	46,5	X0SR203XL		



HAND MUFFS

Ref.	Price	Qty x masterbox
X0SR00		10



SMARTPHONE HOLDERS

	Ref.	Description	Max. Phone Size	Price	Qty x masterbox
	X0SG62H	Smartphone holder	16x8		30
	X0SG71H	Smartphone holder	18x9		30
	X0SG76H	Smartphone holder with pocket	18x9		30
	X0SG00H	X-frame	18x9		45
	*X0SG20H	Smartphone holder	6x12		20
	X0SG62M	Smartphone holder	16x8		30
	X0SG71M	Smartphone holder	18x9		30
	X0SG76M	Smartphone holder with pocket	18x9		30
	X0SG00M	X-frame	18x9		45

Ref.	Spare Parts Smartphone holders	Price
203966R	Handlebar fitting	
203967R	Mirror fitting	

Ref.	Spare Parts Smartphone holders	Price
X1SGMAR	Mirror adapter	
203884R	Safety Net	

ATV CASES

ATV110



Ref.	Description	Price
D0Q1100		
200537R	Locking system	
D1TV80R	Handle	
D1BQ8CAR	Reflector	
D0RI50	Backrest	
S1Q8BOR	Screw set	
D1Q11ETR	Stickers	
201528R	Lid stop strap	
200035R	Spring	

ATV80



Ref.	Description	Price
S0Q800		
200451R	Locking system	
D1TV80R	Handle	
D1BQ8CAR	Reflector	
D0RI50	Backrest	
S1Q8BOR	Screw set	
500545R	Stickers	
200452R	Lid stop strap	
200035R	Spring	

ATV40



Ref.	Description	Price
D0Q200		
200537R	Locking syst	
S1Q8BOR	Screw set	
500545R	stickers	
201481R	Lid stop strap	

COMFORT SEATS

Make, model and year	Ref.	Description	Price
KAWASAKI			
Z750 (07-13) / Z1000 (07-09)	SHK0Z1000C	BLACK, with DARK GREY seams	
YAMAHA			
T.MAX 500/530 (08-16)	SHY0T5320	BLACK, with WHITE seams	
FAZER FZ6 600 (04-10)	SHY0F7000	BLACK, with GREY seams	
MT 09 (13-18)	SHY0M9300	BLACK, with GREY seams	
PIAGGIO			
MP3 RL (07-12) / MP3 RST 125-250-100 (09-12) / MP3 LT 250-400 (09-13) MP3 500 SPORT/ BUSINESS (11-13)	SHV0M2320	BLACK, with GREY-BLUE seams	
HONDA			
CBR600F (2011-12) *	SHH0B6200	BLACK, with GREY seams	
	*SHH0B6209	BLACK, with RED seams	
	*SHH0B6201	BLACK, with BLUE seams	

* Until stock ends

SHAD LOCKS

	Ref.	Description	Size	Measures	Price	Qty x master box
	SERIE 3	C0S303H	3	39x 4,4x3,8		12
		C0S305H	5	44,5x 4,4x3,8		
		C0S307H	7	50x4,4x3,8		
	SERIE 2	C0S203H	3	39x 4,4x3,8		
		C0S205H	5	44,5x 4,4x3,8		
		C0S207H	7	50x4,4x3,8		

WHY SHAD



reddot winner 2021



TERRA

TERRA SET / TR48 TR36 TR47



DESIGN IN BARCELONA

Since 1973

SINCE
1973



1.-WE MANUFACTURE FOR THE TOP BRANDS

The SHAD brand is part of NAD SL, a company with almost 50 years of experience, the market leader for OEM manufactures of motorcycle seats and cases for top brands such as BMW, Triumph, KTM, Honda, ...



2.- THE MOST DESIGN AWARDED MOTORCYCLE CASES

The eXpandable cases SH58X/SH59X won the Red Dot Design Award 2017; the SH36 side cases won the Red Dot 2015 as well as the German Design Award 2017. In recent years, SHAD has achieved various international design awards for the Terra cases, Expandable top cases and the SH36 side case. Awards that reinforce our market position that our brand is achieving in terms of design and functionality for riders.



3.- INNOVATION

Our commitment to R&D has brought to the market many innovative solutions: eXpandable top cases, 3P system & 4P System, Pin system tank bags and all of our locking systems.



4.- DESIGNED IN BARCELONA

All of our products are entirely designed and developed at our Barcelona headquarters. Moreover, we have a various production centers located in the Barcelona area.



5.-GROWING WORLDWIDE PRESENCE

Present in 5 continents, we distribute our products to more than 80 countries.



6.-SOCIAL & ENVIRONMENTAL RESPONSIBILITY

We focus on promoting a responsible production processes, we take care to do our part to protect the planet and giving a helping hand to a global network everywhere we operate.



7.-WARRANTY & QUALITY

All our products are subjected to exhaustive quality controls and have a warranty period according to local legislation; as long as the recommendations for use and assembly indicated by SHAD are respected.



8.- RESISTANT & LIGHTWEIGHT FITTINGS

We create fitting systems adapted to different types of motorcycles and their use. Systems that are visually integrated on the motorcycle and ensure the strongest and safest solutions.



9.-COMFORT & EASY USE

Our cases are designed to be carried around easily. In addition, our locking systems can be operated with one hand.



10.- TOP CASE MOUNTING

Most of our top cases include the mounting plate and screw set to be installed in an easy and comfortable way. For Terra top cases, there are 3 mounting plate options available.



OUR CUSTOMERS

Every day we take on new technical and design challenges to maintain the trust of our customers.



THE COMPANY

SHAD ENGINEERED FOR RIDING

NAD, founded in 1973 and owner of the SHAD brand, is a leader in the manufacture of seats and cases for the main manufacturers in the motorcycle industry.

This year we are celebrating 30 years of SHAD in the market, and we reaffirm our commitment to innovation. On this anniversary we want to thank our team of collaborators, suppliers and, especially our customers, for the trust and support they have always given to us.

Focusing on engineering and design, we will continue to offer solutions in more than 80 countries. This year we confirm NAD-SHAD's commitment to the "ADVENTURE" sector, after a year in which our range of TERRA aluminum cases has been recognized with prestigious international design awards.



Present in **80** countries

2021 Figures
+ 5000 points of sale
+ 900.000 products sold



CIAO
HOLA



ENGINEERED FOR RIDING

DESIGN IN BARCELONA
Since 1973

RESEARCH



IDEATION

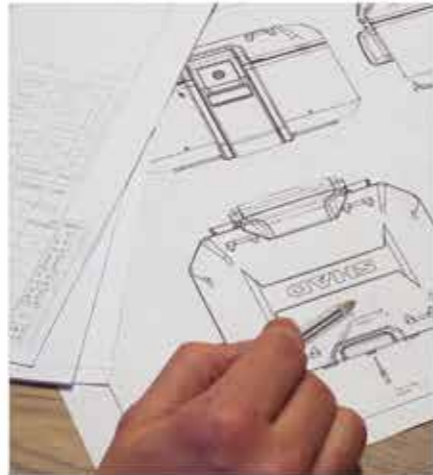

PROTOTYPING



TESTING



IMPLEMENTATION



3P SYSTEM
2015
PATENTED

3 points fitting kit. Integration, lightness and flexibility.



GERMAN DESIGN AWARD 2017
reddot design award winner 2015
SIDE CASES SH36

EXPANDABLE
2016
PATENTED

Adjustment of the top case volume. Capacity and Aerodynamics.



reddot design award winner 2017
EXPANDABLE CASES SH36

Pin System
2017
PATENT PENDING

Integrated and multiadaptable fitting mechanism.



SHAD TERRA
2018
PATENT PENDING



reddot winner 2021
DESIGN AWARD 2021
ABC INTELLECTUAL PROTECTION

SHADLOCKS
ENGINEERED FOR RIDING
2021
PATENT PENDING

Set of patents to protect the intellectual property of this product



SHAD TERRA
2022
PATENT PENDING

Practical and secure double locking system



TR40

CIAO HOLA



Our strategic approach is based on engineering and design. We kickoff the development process of SHAD products starting with the analysis of market trends and base them according to the needs of our customers.

Our creation process is finalized after an exhaustive period of numerous laboratory tests and prototypes.

Bringing together design and engineering, coupled with almost 50 years of experience in the sector, has allowed us to:

- Create innovative SHAD products for the main brands in the sector.
- Obtain a set of patented products to technically differentiate us from the rest.
- Win important international design awards.

- Distribute our product to more than 80 countries.
- Participate in exhibitions and fairs worldwide.
- Be championship sponsors of SUPERBIKES.

For NAD-SHAD, innovation is a way of life and a commitment that we maintain.

QUALITY CASES LAB

Quality

The quality of our products is based on continuous improvement, excellence in management and customer satisfaction. We test the product throughout the whole production and development process both in external and our own spe-

cialized laboratories, guaranteeing compliance with rigorous quality standards, checking every detail, from the raw material to the final product to be delivered to the customer.



PAINT ADHERENCE TEST

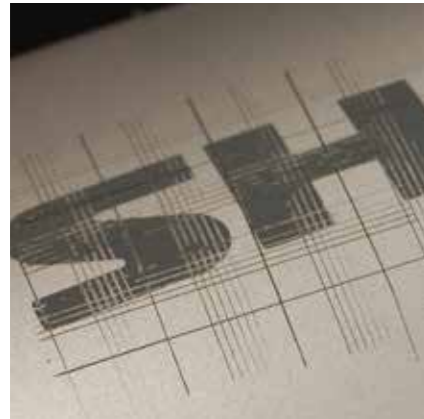

SHAKER TEST

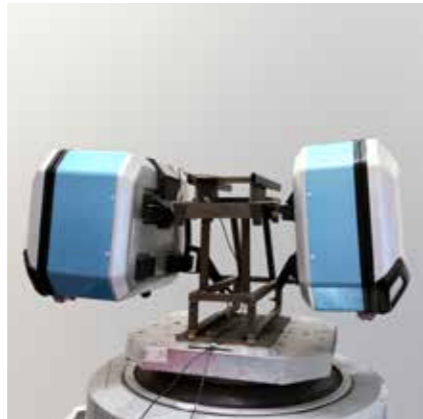

WATERPROOF TEST



WEATHERING TEST



TRACTION TEST



IMPACT TEST



CIAO HOLA



RESOURCE REDUCTION (per year):

- 60000 pages of paper (A4) (277.5Kg)
- 17.3 TONS of iron
- 6.7 TONS of plastic
- 47.8 TONS CO2

ISO 14001:2015 RAW MATERIALS COMPLY WITH ENVIRONMENTAL REGULATIONS

- 100% from wind power
- 100% cleaning products EU Ecolabel
- 100% Electric forklifts
- 100% LED lighting in production centres
- Free Electric vehicles charging points in HQ
- 100% Water based glues in seats production
- 100% Ecological dismoulding Spray for seats production
- 50-50% Recyclable and Reusable packaging For OEM projects
- 15% Energetic Savings in our factories
- 900 trees planted in our SHAD forest

OUR FUTURE IS ALSO GREEN

- NEW INTELLIGENT WAREHOUSE
- 30% Autoproduced Solar Energy in HQ by 2022
- 100% Self-sustaining factory Solar panels Natural Lighting Skylight fans
- 5,7 t./year paper reduction by 2022 due to digital user manuals
- 2000 trees in our SHAD forest
- 100% Paper free invoicing by 2022



JUST ENTER AND SEE HOW



SOCIAL RESPONSIBILITY AND COLLABORATION

ENVIRONMENTAL



INDUSTRY (CLUSTERS)



SOCIAL APPROACH & COMMUNITY



SPONSORSHIPS



f @SHAD.Motorcycle.Cases
i @Shad_motorcycle_cases
v SHAD Motorcycle cases



@alessio.mothotherapy



@blackoleum



@guidobasso



@riding_with_god



@motoaddicted_



@roby_katia_ontheroad



@cadaunosumoto



@motoaddicted_



@Maharidikamotovlog



@ridetobe



@frene_mt



@motoaddicted_



@ivanma_bcn



@Wanderer.ankit



@math_advrider



TERRA
BLACK EDITION
ALUMINIUM CASES

SHAD
TERRA
ENGINEERED FOR RIDING



TERRA SET / **TR48 TR36 TR47** BLACK EDITION

MORE INFO



SHAD TERRA

ENGINEERED FOR RIDING



reddot winner 2021



TERRA LOCK SYSTEM PATENT PENDING

AISI 304
STAINLESS STEEL
INTEGRATED LOCK SYSTEM

INTEGRATED CARRYING HANDLE



HARDENED ALUMINIUM ALLOY:
MAXIMUM RESISTANCE &
MINIMUM WEIGHT



LOCK SYSTEM

DOUBLE LOCKING PATENTED SYSTEM: QUICK & EASY TO INSTALL AND REMOVE

1 Key and 1 hand for all operations, place, remove, open and close.



CAPACITY

UP TO TWO HELMET CAPACITY



PREMIUM KEY

+ ANTIDUST PROTECTOR



SIDE OPENING

QUICK AND EASY ACCESS TO STORE YOUR BELONGINGS



DETAILS

EXTRA CARGO HOOKS



STAINLESS STEEL HINGES



RETRACTABLE FOLDING TRAY



INNER CARPET FOR TOP CASES



TR48

X49,5 Y41,8 Z32,2 (cm)
Ref. D0TR48100

PATENT PENDING



PATENT PENDING



reddot winner 2021



TR48

BLACK EDITION

ALUMINIUM CASES

X49,5 Y41,8 Z32,2 (cm)

Ref. D0TR48100B



FEATURES



Icons description Page 130

ACCESSORIES

BACKREST
Ref. D0RI75



INNER BAG EXPANDABLE
Top - Side
Ref. X0IB47



REQUIRED

OPTION 1

ALUMINIUM PLATE + SCREWS

D1BTRPA



OPTION 2

ALUMINIUM PLATE + SCREWS

D1BTRPA2



OPTION 3

BIG PLATE + SCREWS

D1B591PA



FEATURES



Icons description Page 130

ACCESSORIES

BACKREST
Ref. D0RI75



INNER BAG EXPANDABLE
Top - Side
Ref. X0IB47



REQUIRED

OPTION 1

ALUMINIUM PLATE + SCREWS

D1BTRPA



OPTION 2

ALUMINIUM PLATE + SCREWS

D1BTRPA2



OPTION 3

BIG PLATE + SCREWS

D1B591PA



TR37

X49,5 Y41,8 Z25,9 (cm)
REF. D0TR37100

PATENT PENDING



PATENT PENDING



reddot winner 2021



TR37

BLACK EDITION

ALUMINIUM CASES

X49,5 Y41,8 Z25,9 (cm)
Ref. D0TR37100B



FEATURES



Icons description Page 130

ACCESSORIES

BACKREST
Ref. D0RI75



INNER BAG EXPANDABLE
Top - Side
Ref. X0IB47



REQUIRED

OPTION 1

ALUMINIUM PLATE + SCREWS

D1BTRPA



OPTION 2

ALUMINIUM PLATE + SCREWS

D1BTRPA2



OPTION 3

BIG PLATE + SCREWS

D1B591PA



FEATURES



Icons description Page 130

ACCESSORIES

BACKREST
Ref. D0RI75



INNER BAG EXPANDABLE
Top - Side
Ref. X0IB47



REQUIRED

OPTION 1

ALUMINIUM PLATE + SCREWS

D1BTRPA



OPTION 2

ALUMINIUM PLATE + SCREWS

D1BTRPA2



OPTION 3

BIG PLATE + SCREWS

D1B591PA



TR47L
BLACK EDITION
 ALUMINIUM CASES
 X49,5 Y41,8 Z34,5 (cm)
 Ref. LEFT D0TR47100LB



PATENT PENDING



PATENT PENDING



reddot winner 2021



TR47R
BLACK EDITION
 ALUMINIUM CASES
 X49,5 Y41,8 Z34,5 (cm)
 Ref. RIGHT D0TR47100RB



FEATURES



Icons description Page 130

FEATURES



Icons description Page 130

ACCESSORIES

OPTIONAL INNER MESH
 FOR SIDE CASE
 Ref. X0TR01



RETRACTABLE TRAY
 INCLUDED

OPTIONAL INNER BAG
 INNER BAG / EXPANDABLE
 Ref. TOP - SIDE X0IB47

ACCESSORIES



RETRACTABLE TRAY
 INCLUDED

OPTIONAL INNER BAG
 INNER BAG / EXPANDABLE
 Ref. TOP - SIDE X0IB47

REQUIRED

LOCK CYLINDERS + KEYS

NOT INCLUDED
 REF. D1TRB0R



WARNING! ⚠️

LOCK CYLINDER + KEYS NOT INCLUDED

INCLUDED

INNER MESH



LOCK CYLINDERS + KEYS



TR47L

X49,5 Y41,8 Z34,5 (cm)
Ref. LEFT D0TR47100L



PATENT PENDING



PATENT PENDING



reddot winner 2021



TR47R

X49,5 Y41,8 Z34,5 (cm)
Ref. RIGHT D0TR47100R



FEATURES



Icons description Page 130

FEATURES



Icons description Page 130

ACCESSORIES

OPTIONAL INNER MESH
FOR SIDE CASE
Ref. X0TR01



RETRACTABLE TRAY
INCLUDED

OPTIONAL INNER BAG
INNER BAG / EXPANDABLE
Ref. TOP - SIDE X0IB47

ACCESSORIES



RETRACTABLE TRAY
INCLUDED

OPTIONAL INNER BAG
INNER BAG / EXPANDABLE
Ref. TOP - SIDE X0IB47

REQUIRED

LOCK CYLINDERS + KEYS

NOT INCLUDED
REF. D1TRB0R



WARNING! ⚠

LOCK CYLINDER +
KEYS NOT INCLUDED

INCLUDED

INNER MESH



LOCK CYLINDERS + KEYS



TR36L

BLACK EDITION

ALUMINIUM CASES

X49,5 Y41,8 Z28,2 (cm)

Ref. LEFT D0TR36100LB



PATENT PENDING



PATENT PENDING



reddot winner 2021



TR36R

BLACK EDITION

ALUMINIUM CASES

X49,5 Y41,8 Z28,2 (cm)

Ref. RIGHT D0TR36100RB



FEATURES



Icons description Page 130

ACCESSORIES

OPTIONAL INNER MESH
FOR SIDE CASE
Ref. X0TR01



RETRACTABLE TRAY
INCLUDED

OPTIONAL INNER BAG
INNER BAG / EXPANDABLE
Ref. TOP - SIDE X0IB47

REQUIRED

LOCK CYLINDERS + KEYS

NOT INCLUDED
REF. D1TRB0R



WARNING! ⚠

LOCK CYLINDER +
KEYS NOT INCLUDED

FEATURES



Icons description Page 130

ACCESSORIES



RETRACTABLE TRAY
INCLUDED

OPTIONAL INNER BAG
INNER BAG / EXPANDABLE
Ref. TOP - SIDE X0IB47

INCLUDED

INNER MESH



LOCK CYLINDERS + KEYS



TR36L

X49,5 Y41,8 Z34,5 (cm)
Ref. LEFT D0TR47100L



PATENT PENDING



PATENT PENDING



reddot winner 2021



TR36R

X49,5 Y41,8 Z34,5 (cm)
Ref. RIGHT D0TR47100R



FEATURES



Icons description Page 130

FEATURES



Icons description Page 130

ACCESSORIES

OPTIONAL INNER MESH
FOR SIDE CASE
Ref. X0TR01



RETRACTABLE TRAY
INCLUDED

OPTIONAL INNER BAG
INNER BAG / EXPANDABLE
Ref. TOP - SIDE X0IB47

ACCESSORIES



RETRACTABLE TRAY
INCLUDED

OPTIONAL INNER BAG
INNER BAG / EXPANDABLE
Ref. TOP - SIDE X0IB47

REQUIRED

LOCK CYLINDERS + KEYS

NOT INCLUDED
REF. D1TRB0R



WARNING! ⚠

LOCK CYLINDER +
KEYS NOT INCLUDED

INCLUDED

INNER MESH



LOCK CYLINDERS + KEYS



HOW TO BUY YOUR TERRA CASE

TOP CASE

1 CHOOSE YOUR TERRA CASE

SIDE CASE

CHOOSE YOUR TERRA RIGHT CASE 1

TR48 TR37



TR37 TR48
BLACK EDITION BLACK EDITION



TR47R TR36R



TR47R TR36R
BLACK EDITION BLACK EDITION



2 CHOOSE YOUR MOUNTING PLATE

CHOOSE YOUR TERRA LEFT CASE 2

ALUMINIUM PLATE + SCREWS

D1BTRPA



D1BTRPA2



BIG PLATE + SCREWS

D1B591PA



TR36L TR47L



TR36L TR47L
BLACK EDITION BLACK EDITION



3 CHOOSE YOUR TOP MASTER

CHOOSE YOUR 4P SYSTEM 3

Bike compatibility



WATCH OUT
EXHAUST PIPE
SIDE
Always TR36

Bike compatibility



4P
SYSTEM



NEW TR40

X40 Y25 Z38 (cm)
Ref. X0TR401

PATENT PENDING



INCLUDED

DRY BAG + BAG HOLDER FUEL BOTTLE HARNESS



DETAILS

4 SIDE + 2 TOP DURAFLEX CAMBUCKLES ADJUST THE BAG TO THE SIZE OF THE LOAD

AIRCRAFT GRADE ANODIZED ALUMINUM BUCKLES

REFLECTIVE ELEMENTS

2 MOLLE SYSTEM GRIDS PER BAG



FEATURES



Icon descriptions Page 130

PATENT PENDING

DOUBLE LOCKING SYSTEM

QUICK MOUNTING & QUICK LOCKING: ONE KEY TO OPEN AND RELEASE. LOCK ACCESS TO INSIDE OF THE BAG



PREMIUM LOCK

+ ANTIDUST PROTECTOR



ULTRA DURABLE MATERIAL

1500h UV protection

Abrasion resistance **50.000 cycles**

Reinforced stitching

Reinforced bottom structure

WATERPROOF

DOUBLE ROLL BAGS: OUTER BAG AND INCLUDED INNER BAG ENSURES WATER-PROOFNESS



INSTALLATION TO 4P SYSTEM

HEAVY DUTY 4P MOUNTING PLATE MADE OF POLYAMIDE 30% GLASS FIBER



SIDE FITTING not included



+ info Page 96

TOP CASES



reddot design award
winner 2017

THE MOST DESIGN-AWARDED MOTORCYCLE CASES



EXPANDABLE CASE

MAXIMUM VERSATILITY



PATENTED



reddot design award
winner 2017

DESIGNED & MADE IN BARCELONA

Since 1973



TESTED IN MOROCCO HONDA EPIC TOUR

MOTODYNAMICS



EASY TO EXPAND

3 POSITIONS:



FEATURES

STRUCTURAL FRAME



Transform in seconds from a large case to a small aerodynamic one

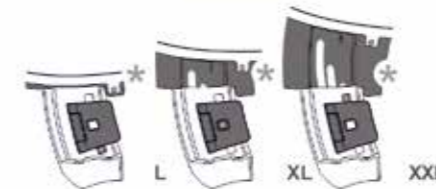
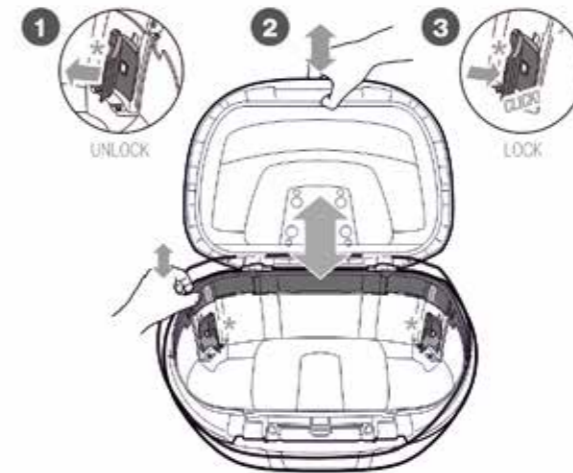

SH59X

X48 Y61 Z27/29/31.5 (cm)
Ref. D0B59200

PATENTED



reddot design award
winner 2017



EXPANDABLE CASE



DAILY



WEEKEND



HOLIDAYS



FEATURES



Icons description Page 130

INCLUDED

STANDARD PLATE

PREMIUM SMART LOCK



ACCESSORIES

BACKREST
Ref. DORI80



INNER BAG
Ref. X0IB10



X 21/29 Y 53 Z 34 (cm)
EXPANDABLE

ALUMINIUM PLATE +
SCREWS
Ref. D1BTRPA



ALUMINIUM PLATE +
SCREWS
Ref. D1BTRPA2



BRAKE LIGHT
Ref. D0B29KL



LED

SH58X

X48 Y61 Z27/29/31.5 (cm)
Ref. D0B58206

PATENTED



red dot design award
winner 2017



EXPANDABLE CASE



L

DAILY



XL

WEEKEND



XXL

HOLIDAYS

CARBON
Ref. D0B58206



NEW TITANIUM
Ref. D0B58206 +
D1B58E15



WHITE
Ref. D0B58206 +
D1B58E08



BLACK METAL
Ref. D0B58206 +
D1B58E21



BACKREST
Ref. DORI80



INNER BAG
Ref. X0IB10



X 21/29 Y 53 Z 34 (cm)
EXPANDABLE

ACCESSORIES

ALUMINIUM PLATE +
SCREWS
Ref. D1BTRPA



ALUMINIUM PLATE +
SCREWS
Ref. D1BTRPA2



BRAKE LIGHT
Ref. D0B29KL



LED

FEATURES



Icons description Page 130

INCLUDED

STANDARD PLATE



PREMIUM SMART LOCK



SH50

X46 Y60 Z32 (cm)
Ref. D0B5000



BLACK
Ref. D0B5000



WHITE
Ref. D0B5000 + D1B50E08



BLUE
Ref. D0B5000 + D1B50E01



RED
Ref. D0B5000 + D1B50E09



SILVER
Ref. D0B5000 + D1B50E05



BLACK METAL
Ref. D0B5000 + D1B50E21



UNPAINTED COVER
Ref. D1B50ER



FEATURES



Icons description Page 130

INCLUDED

STANDARD PLATE



BACKREST



ACCESSORIES

INNER BAG
Ref. X0IB00



X 35 Y 50 Z 21 (cm)

LUGGAGE RACK
Ref. D0PS00



BRAKE LIGHT
Ref. D0B29KL



LED

SH48

DARK GREY

X46 Y61 Z31 (cm)
The lightest in its range
Ref. D0B48306R



DARK GREY
Ref. D0B48300 [no cover]



CARBON
Ref. D0B48300 + D1B48E06



CARBON + BACKREST
Ref. D0B48306R



WHITE
Ref. D0B48300 + D1B48E08



DARK GREY
Ref. D0B48300 + D1B48E17



BLACK METAL
Ref. D0B48300 + D1B48E21



FEATURES



Icons description Page 130

INCLUDED

STANDARD PLATE



PREMIUM SMART LOCK



ACCESSORIES

BACKREST
Ref. D0RI4800



INNER BAG
Ref. X0IB00



X 35 Y 50 Z 21 (cm)

LUGGAGE RACK
Ref. D0PS00



ALUMINIUM
PLATE + SCREWS
Ref. D1BTRPA



ALUMINIUM
PLATE + SCREWS
Ref. D1BTRPA2



BRAKE LIGHT
Ref. D0B29KL



LED

SH48

NEW TITANIUM

X46 Y61 Z31 (cm)
The lightest in its range
Ref. D0B48406R



NEW TITANIUM
Ref. D0B48400 [no cover]



CARBON
Ref. D0B48400 + D1B48E06



CARBON + BACKREST
Ref. D0B48406R



WHITE
Ref. D0B48400 + D1B48E08



NEW TITANIUM
Ref. D0B48400 + D1B48E15



BLACK METAL
Ref. D0B48400 + D1B48E21



FEATURES



Icons description Page 130

INCLUDED

STANDARD PLATE PREMIUM SMART LOCK



ACCESSORIES

BACKREST
Ref. D0RI4800



INNER BAG
Ref. X0IB00



X 35 Y 50 Z 21 (cm)

LUGGAGE RACK
Ref. D0PS00



ALUMINIUM PLATE + SCREWS
Ref. D1BTRPA2



BRAKE LIGHT
Ref. D0B29KL



LED

SH47

RED

X42 Y57,5 Z31,2 (cm)
Ref. D0B47206



SH47

WHITE

X42 Y57,5 Z31,2 (cm)
Ref. D0B47106



FEATURES



Icons description Page 130

INCLUDED

STANDARD PLATE



ACCESSORIES

INNER BAG
Ref. X0IB00



X 35 Y 50 Z 21 (cm)

BACK REST
Ref. D0RI47



BRAKE LIGHT
Ref. D0B40KL



LED

COLOUR COVERS
Ref. D1B47E...

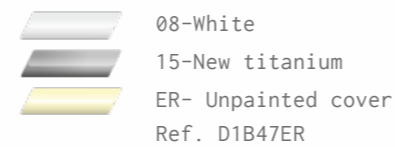

Ref. D1B47ER

FEATURES



Icons description Page 130

INCLUDED

STANDARD PLATE



ACCESSORIES

INNER BAG
Ref. X0IB00



X 35 Y 50 Z 21 (cm)

BACK REST
Ref. D0RI47



LIGHT
Ref. D0B40KL



LED

COLOUR COVERS
Ref. D1B47E...

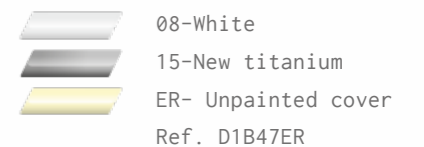

Ref. D1B47ER

SH46

X42 Y58 Z31 (cm)
Ref. D0B46200



FEATURES



Icons description Page 130

INCLUDED

STANDARD PLATE



ACCESSORIES

BACKREST
Ref. D0RI50



INNER BAG
Ref. X0IB00



X 35 Y 50 Z 21 (cm)

LUGGAGE RACK
Ref. D0PS00



BRAKE LIGHT
Ref. D0B40KL



LED

SH45

X41 Y56.4 Z31.4 (cm)
Ref. D0B45100 + D1B45E05



FEATURES



Icons description Page 130

INCLUDED

STANDARD PLATE



ACCESSORIES

BACKREST
Ref. D0RI60



INNER BAG
Ref. X0IB00



X 35 Y 50 Z 21 (cm)

BRAKE LIGHT
Ref. D0B40KL



LED

No cover top case Ref. D0B45100
COLOUR COVERS
Ref. D1B45E...

-  01-Blue
-  05-Silver
-  08-White
-  09-Red
-  21-Black

NEW SH44

X43,5 Y55 Z31,5 (cm)
Ref. D0B44100



FEATURES



Icons description Page 130

INCLUDED

STANDARD PLATE



ACCESSORIES

BACKREST
Ref. D0RI60



BRAKE LIGHT
Ref. D0B40KL



LED

INNER BAG
Ref. X0IB00



X 35 Y 50 Z 21 (cm)

SH40

X42,5 Y49,5 Z29,6 (cm)
Ref.: D0B40100+D1B40E08



Alu look top case.
Ref. D0B40200



FEATURES



Icons description Page 130

INCLUDED

STANDARD PLATE



ACCESSORIES

BACKREST
Ref. D0RI60









BRAKE LIGHT
Ref. D0B40KL



LED

No cover top case Ref. D0B40100
COLOUR COVERS
Ref. D1B40E...

-  01-Blue
-  05-Silver
-  08-White
-  09-Red
-  21-Black
-  Unpainted Cover
Ref. D1B40ER

SH40

CARGO

X42.5 Y49.2 Z32.5 (cm)
Ref. D0B40199



FEATURES



Icons description Page 130

INCLUDED

STANDARD PLATE



ACCESSORIES

BACKREST
Ref. D0RI60



BRAKE LIGHT
Ref. D0B40KL



LED

SH39

X43 Y51 Z32 (cm)
Ref. D0B39106



FEATURES



Icons description Page 130

INCLUDED

STANDARD PLATE



ACCESSORIES

BACKREST
Ref. D0RI3900



BRAKE LIGHT
Ref. D0B40KL



LED

No cover top case Ref. D0B39100
Carbon cover top case Ref. D0B39106
COLOUR COVERS
Ref. D1B39E...

-  08-White
-  15-New titanium
-  21-Black
-  Unpainted cover
Ref. D1B39ER

SH37

X40 Y49 Z31 (cm)
Ref. D0B37100+D1B37E08



SH34

X42 Y43 Z31 (cm)
Ref. D0B34106



FEATURES



Icons description Page 130

INCLUDED

STANDARD PLATE



ACCESSORIES

BACKREST
Ref. D0RI60







BRAKE LIGHT
Ref. D0B29KL



LED

No cover top case Ref. D0B37100
COLOUR COVERS
Ref. D1B37E...

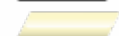
-  01-Blue
 -  05-Silver
 -  08-White
 -  09-Red
 -  21-Black
 -  Unpainted cover
- Ref. D1B37ER

FEATURES



Icons description Page 130

INCLUDED

STANDARD PLATE



ACCESSORIES

BACKREST
Ref. D0RI40



BRAKE LIGHT
Ref. D0B29KL



LED

SH33

X42 Y43 Z31 (cm)
Ref. D0B33200+D1B33E21



FEATURES



Icons description Page 130

INCLUDED

STANDARD PLATE



ACCESSORIES

BACKREST
Ref. D0RI40









BRAKE LIGHT
Ref. D0B29KL



LED

No cover top case Ref. D0B33200
COLOUR COVERS
Ref. D1B33E8...

-  01-Blue
-  08-White
-  09-Red
-  15-New titanium
-  21-Black
-  Unpainted cover
Ref. D1B332ER

SH29

X38 Y40 Z30 (cm)
Ref. D0B29100+D1B29E05



FEATURES



Icons description Page 130

INCLUDED

STANDARD PLATE



ACCESSORIES

BACKREST
Ref. D0RI40



BRAKE LIGHT
Ref. D0B29KL



LED

No cover top case Ref. D0B29100
COVER COLOURS
Ref. D1B29E...

-  01-Blue
-  08-White
-  09-Red
-  21-Black
-  Unpainted cover
Ref. D1B29ER

SH26

X40.5 Y40 Z28.2 (cm)
Ref. D0B26100



FEATURES



Icons description Page 130

INCLUDED

STANDARD PLATE



ACCESSORIES

BRAKE LIGHT
Ref. D0B29KL



LED

SIDE CASES



reddot design award
winner 2017



GERMAN
DESIGN
AWARD
SPECIAL
2017



SH35

X51 Y30 Z38 (cm)
Ref. D0B35200



Retractable handle
Elastic strap
Structural frame
Inner tray



FEATURES



Icons description Page 130

INCLUDED

EXTRA LOCK FOR YOUR TOP CASE



PREMIUM LOCK - 1 HAND USE



ACCESSORIES

INNER BAG
Ref. X0IB36



X 28 Y 41 Z 31 (cm)

SIDE FITTING



PATENTED

3P
SYSTEM

+ info Page 97

4P
SYSTEM

+ info Page 96



SH36

X51 Y33 Z38 (cm)
The lightest in its range
Ref. D0B36200



reddot design award
winner 2015



THE MOST DESIGN-AWARDED
SIDE CASES SH36



Modular Helmet XXL
Retractable Handle
Elastic strap
Structural frame
Inner tray



CARBON
Ref. D0B36200



WHITE
Ref. D0B36200+D1B36E08



NEW TITANIUM
Ref. D0B36200+D1B36E15



BLACK METAL
Ref. D0B36200+D1B36E21



FEATURES



Icons description Page 130

INCLUDED

EXTRA LOCK FOR YOUR TOP CASE



PREMIUM
LOCK - 1 HAND USE



INNER BAG
Ref. X0IB36



X 28 Y 41 Z 31 (cm)

ACCESSORIES

RED REFLECTION
Ref. D1B36CAR



SIDE FITTING



PATENTED



+ info Page 97



+ info Page 96



SH23

X49 Y26 Z35 (cm)
Ref. D0B23100+D1B23E08



BLACK
Ref. D0B23100

WHITE
Ref. D0B23100 +
D1B23E08

NEW TITANIUM
Ref. D0B23100 +
D1B23E15

ALU LOOK COVER
INCLUDED
Ref. D0B23200W



FEATURES



Icons description Page 130

INCLUDED

EXTRA LOCK FOR YOUR TOP CASE



SIDE FITTING



PATENTED



+ info Page 97

ACCESSORIES FOR CASES

BACKRESTS



INNER BAGS

Ref. X0IB47 → EXPANDABLE



Ref. X0IB00



Ref. X0IB10 → EXPANDABLE



Ref. X0IB36



UPPER RACK



COLOUR COVERS



BRAKE LIGHTS

Ref. D0B40KL



Ref. D0B29KL



INNER MESH

Ref. X0TR01



TOP CASES

	Backrest	Inner bags	Upper rack	Brake lights	Colour covers*
TR37/TR37B	D0RI75	X0IB47			
TR48/TR48B	D0RI75	X0IB47			
SH59X	D0RI80	X0IB10		D0B29KL	
SH58X	D0RI80	X0IB10		D0B29KL	☐ ☐ ☐
SH50	INCLUDED	X0IB00	D0PS00	D0B29KL	☐ ☐ ☐ ☐ ☐ ☐
SH48 Dark Grey	D0RI4800	X0IB00	D0PS00	D0B29KL	☐ ☐ ☐ ☐ ☐
SH48 New Titanium	D0RI4800	X0IB00	D0PS00	D0B29KL	☐ ☐ ☐ ☐ ☐
SH47 Red	D0RI47	X0IB00		D0B40KL	☐ ☐ ☐ ☐ ☐
SH47 White	D0RI47	X0IB00		D0B40KL	☐ ☐ ☐ ☐ ☐
SH46	D0RI50	X0IB00	D0PS00	D0B40KL	
SH45	D0RI60	X0IB00		D0B40KL	☐ ☐ ☐ ☐ ☐
SH44	D0RI60	X0IB00		D0B40KL	
SH40	D0RI60			D0B40KL	☐ ☐ ☐ ☐ ☐
SH40 CARGO	D0RI60			D0B40KL	
SH39	D0RI3900			D0B40KL	☐ ☐ ☐ ☐ ☐
SH37	D0RI60			D0B29KL	☐ ☐ ☐ ☐ ☐ ☐
SH34	D0RI40			D0B29KL	
SH33	D0RI40			D0B29KL	☐ ☐ ☐ ☐ ☐ ☐
SH29	D0RI40			D0B29KL	☐ ☐ ☐ ☐ ☐ ☐
SH26				D0B29KL	

SIDE CASES

	INNER BAGS	INNER MESH	COLOUR COVERS*
TR36/TR36B	X0IB47	X0TR01	
TR47/TR47B	X0IB47	X0TR01	
SH36	X0IB36		☐ ☐ ☐
SH35	X0IB36		
SH23			☐ ☐

* PLEASE CHECK EVERY CASE CATALOGUE PAGE TO SEE REFERENCES

Blue
 Silver
 Carbon
 White
 Red
 New titanium
 Dark Grey
 Black
 Non painted cover



FITTING KITS

TOP CASES



SIDE CASES



SIDE BAG HOLDER



SIDE BAG HOLDER SR



BAGS / OTHERS

BIKE COMPATIBILITY



BACKRESTS



Scooter



Custom



BIKE COMPATIBILITY

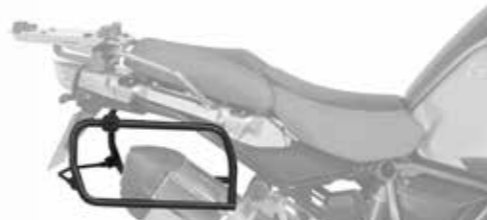

DURABILITY
Designed for hard use. Transversal support to increase strength between the two cases.

MATERIAL
20mm Steel frame. Biggest in the market. Metallic powder coated paint.

COMPATIBLE WITH: TR47L & TR47R, TR47L & TR47R BLACK EDITION, TR36L & TR36R, TR36L & TR36R BLACK EDITION, SH36, SH35.



PATENTED

INTEGRATED DESIGN
Close fit and minimize the aesthetic change of the bike

LIGHTNESS
Nearly no change in the bike's center of gravity, hence improving safety.

COMPATIBLE WITH: SH36, SH35, SH23



MATERIAL
20mm Steel frame. Biggest in the market. Metallic powder coated paint.

PATENTED
3 point to fit the case on the bike.

TOP FITTING

TOP MASTER

Bike compatibility



PIN SYSTEM

QUICK FITTING TANK BAGS



PLATES



S

Small Rack
(INCLUDED)
SH26/SH29/SH33/SH34

M

Medium Rack
(INCLUDED)
SH39/SH40/SH44/SH45/
SH46/SH47

B

Big Rack
SH59X/SH58X/SH50/SH48
(INCLUDED)
TR48/TR37 (not INCLUDED).-
D1B59PA

A

Aluminium Racks
(not included)
SH59X/SH58X/SH48/TR48/
TR37
Aluminium Rack.- D1BTRPA
Black Aluminium Rack.-
D1TRPA2

SIDE BAG HOLDER

Side Bag Holder:
SL58/SE48/SW42



Universal side holder
SL58/SE48/SW42
Ref. D0SS5E



SR Side Bag Holder:
SL58/SE48/SE48SR/SR38



PATENT PENDING

BACKRESTS

SCOOTER

STEP 1. Backrest
Choose your favorite color

Ref. D0RP00

Ref. D0RP08

Ref. D0RP05

Ref. D0RP00N



STEP 2: Fitting kit
Look for your motorcycle model

CUSTOM SISSYBAR

STEP 1.
Backrest



STEP 2.
Top case Rack



Chromed
ref. NADTN

Black
ref. NADTNN



COMFORT SEATS

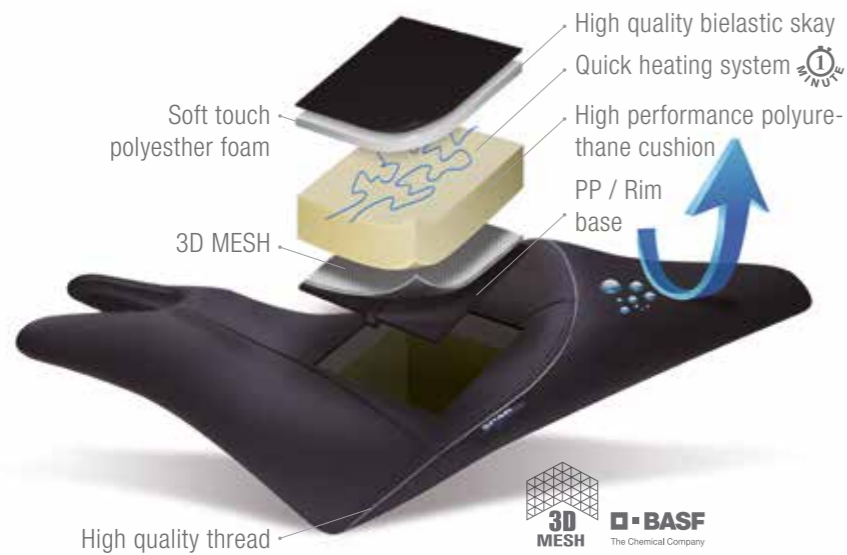

SHAD
style

High quality bielastic skay
Resistant to:



YAMAHA T-MAX

Model and year
T-MAX 500 (2008-13)
T-MAX 530 (2014-16)



Ref. SHY0T5320
Black, with white seams

KAWASAKI Z750-1000

Model and year
Z750 (2007-13)
Z1000 (2007-09)



Ref. SHK0Z1000C
Black, with dark, grey seams

YAMAHA FZ6

Model and year
FAZER FZ6 600 (2004-10)



Ref. SHY0F7000
Black, with grey seams

PIAGGIO MP3

Model and year
MP3 RL (2007-12)
MP3 RST 125-250-100 (2009-12)
MP3 LT 250-400 (2009-13)
MP3 500 SPORT/BUSINESS (2011-13)



Ref. SHV0M2320
Black-white, grey-blue seams

YAMAHA MT-09

Model and year
MT-09 (2013-18)



Ref. SHY0M9300
Black-grey, with grey seams

BAGS



SPORT



TOURING



PIN SYSTEM



CAFE RACER



Genuine

ADVENTURE

100%

WATERPROOF

SPORT & TOURING



SR SIDE BAG HOLDER
SAFETY LOCK WITH KEY
+ info Page 98



CHECK FOR MOTORCYCLE
SPECIFIC FITTING KIT
www.shad.es



NEW E48SR HARD SHELL SADDLE BAGS

X 45 Y 27 Z 29 (cm)
Ref. X0SE48SR



Secure

Locking mechanism secures the case to the bike. Combination locks access to the inside.



Fast

Remove or place the bag on the bike instantly and turn the key. 3 seconds install.



Inner features

Inner bag, compression straps, zippered mesh cover on lid, cushioned inner liner, double reinforced hinges.



Design

Designed in Barcelona: Aerodynamic 3D body, red accent pieces are integrated carrying handles.



Water resistance

Outer hardshell and inner bag ensures waterproofness.



NEW E48

EXPANDABLE SADDLE BAGS

X 47 Y 24/30 Z 29 (cm)
Ref. X0SE481



NEW SL58

EXPANDABLE SADDLE BAGS

X47 Y18/21 Z29 (cm)
Ref. X0SL58



Accessories (pag. 117)

E04

SMALL TANK BAG

X29 Y26 Z10 (cm)
Ref. X0SE04



Accessories (pag. 117)

SL20F

TANK BAG

X40 Y30 Z18/21 (cm)
Ref. X0SL20F



Accessories (pag. 117)

SL12M

SMALL TANK BAG

X30 Y19 Z10 (cm)
Ref. X0SL12M



Accessories (pag. 117)

SC25

SCOOTER BAG

X38 Y27 Z26 (cm)
Ref. X0SC25



SL04

SMALL LEG BAG

X3 Y26 Z13 (cm)
Ref. X0SL04



SL86

BACKPACK

X30 Y27 Z45 (cm)
Ref. X0SL86



SL03

WAIST BAG

X9 Y23 Z16 (cm)
Ref. X0SL03



SL05

BIG LEG BAG

X11 Y25 Z15 (cm)
Ref. X0SL05



SL01

TOLL PASS POUCH

X4 Y6 Z10 (cm)
Ref. X0SL01



BAGS



PATENT PENDING

STEP 1. Choose your bag

E04P

Ref. X0SE04P



E10P

Ref. X0SE10P



E16P

Ref. X0SE16P



STEP 2. Fit to your bike



4 POSITIONS

4 Positions to adapt to your bike
E-10P / E-16P



Bike compatibility



E16P TANK BAG

X40 Y28 Z20/26 (cm)
Ref. X0SE16P



E10P TANK BAG

X31 Y22 Z15 (cm)
Ref. X0SE10P



E04P SMALL TANK BAG

X30 Y21 Z11 (cm)
Ref. X0SE04P



Accessories (pag. 117)

CAFE RACER
SHAD
 ENGINEERED FOR RIDING
SR
Genuine
 SINCE 1973
 INSPIRED IN BARCELONA
 WWW.SHAD.ES



FEATURES



SR28
 TAIL BAG
 Ref. X0SR28

SR18
 TANK BAG
 Ref. X0SR18

SR38
 SADDLE BAG
 Ref. X0SR38

SR18
 TANK BAG
 X36 Y18 Z15(cm)
 Ref. X0SR18

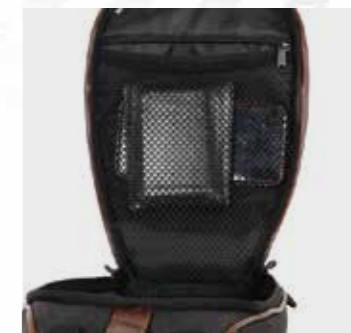

SR28
 TAIL BAG
 X25 Y40 Z26(cm)
 Ref. X0SR28



SR38
 SADDLE BAG
 X24 Y15 Z34 (cm)
 Ref. X0SR38



SAFETY LOCK WITH KEYS



CHECK FOR MOTORCYCLE SPECIFIC FITTING KIT www.shad.es



100% **WATERPROOF**

-  HIGH QUALITY
-  EXTREME TEMPERATURES
-  HIGH RESISTANCE
-  UV PROTECTION



FEATURES



- SW 42**
SADDLE BAGS
- SW 38**
DUFFLE REAR BAG
- SW 22**
MAGNETIC TANK BAG
- SW 45**
REAR BAG
- SW 23**
TANK BAG



- REF: X0SW42
SADDLE BAGS SW42
- REF: X0SW38
REAR DUFFLE SW38
- REF: X0SW22
TANK BAG SW22
- REF: X0SW45
REAR BAG SW45
- REF: X0SW23B
TANK BAG SW23B

ADVENTURE BAGS

100%
WATERPROOF
SEAMLESS
HIGH FREQUENCY WELDING

PVC TARPULIN
3 LAYERS



ROLL CLOSURE



IPX5

QUICK FITTING

EASY TO FIX

FAST



FAST



EXTRALOAD

MOLLE SYSTEM



EXTRA STORAGE FLAP



SW42
SADDLE BAGS
X42 Y17 Z34 (cm)
Ref. X0SW42



Accessories (pag. 117)

100% WATERPROOF

SIDE BAG HOLDER



! CHECK FOR MOTORCYCLE SPECIFIC FITTING KIT
www.shad.es

+ info Page 98

SW23B

TANK BAG

X35 Y26 Z24 (cm)
Ref. X0SW23B



100% WATERPROOF



SW22

TANK BAG

X37 Y19 Z16 (cm)
Ref. X0SW22



IB20

REAR BAG

0 25,5 Z53,5 (cm)
Ref. X0IB20



SW45

REAR BAG

X31 Y48 Z17 (cm)
Ref. X0SW45



ACCESSORIES FOR BAGS

MAGNETS (4U.)

Ref. X1SL11

FOR:

SL20F
SL12M
E22
E04
SW23B



STRAPS

Ref. X1SL09

FOR:

SL20F



RAIN COVER

Ref. X1SL01

FOR:

E04
SL12M
E04P

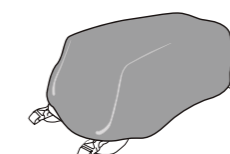

FILM PROTECTOR

Ref. X1SL02

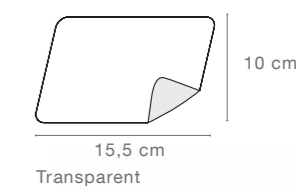

SW38

REAR DUFFLE BAG

X28 Y54 Z28 (cm)
Ref. X0SW38



UNIVERSAL BASE TANK

Ref. X1SL90

FOR:

E22
E04
SL20F
SL12M



DUFFLE BAG

Ref. X0IB08



THERMO PAD

Ref. X1SB97

FOR:

E48
SE48SR
SL58
SW42



SMARTPHONE HOLDERS



MIRROR AND HANDLEBAR SYSTEM



SHAD ENGINEERED MOUNTING SYSTEM



360° SUPPORT

HANDLEBAR SIZES

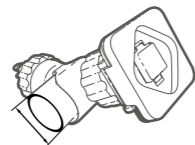

20-40 MM

GLOVE FRIENDLY



SECURITY STRAP



QUICK CLICK SYSTEM

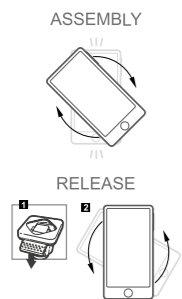

SMARTPHONE CASE



- 1 LIGHT RAIN RESISTANT CASE
- 2 CABLE OUTLET
- 3 TOUCH SCREEN

X-FRAME SYSTEM

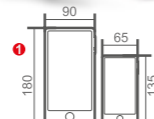

- 1 PHONE SIZES
- 2 SAFETY TETHER
- 3 RUBBER GRIPS
- 4 DESK SUPPORT

X-FRAME

HANDLEBAR HOLDER



MAX. PHONE SIZE

180x90 mm

Ref. X0SG00H

MIRROR HOLDER



Ref. X0SG00M

SMARTPHONE HOLDERS WITH POCKET

HANDLEBAR HOLDER



MAX. PHONE SIZE

180x90 mm

Ref. X0SG76H

MIRROR HOLDER



Ref. X0SG76M

SMARTPHONE HOLDERS

HANDLEBAR HOLDER



MAX. PHONE SIZE

160x80 mm

Ref. X0SG62H

180x90 mm

Ref. X0SG71H

MIRROR HOLDER



Ref. X0SG62M

Ref. X0SG71M

RAIN JACKET

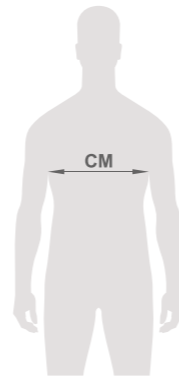

Size	cm	Ref.
S	57	X0SR55S
M	59.5	X0SR55M
L	62	X0SR55L
XL	64.5	X0SR55XL
XXL	67	X0SR55XXL
3XL	69.5	X0SR553XL

HAND MUFFS

X36.5 Y26 Z50 (cm)
Ref. X0SR00

Quick Fitting

Fur lining

Adaptable to a majority of motorcycles



RAIN PANTS

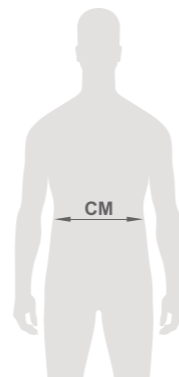

Size	cm	Ref.
S	34	X0SR20S
M	36.5	X0SR20M
L	39	X0SR20L
XL	41.5	X0SR20XL
XXL	44	X0SR20XXL
3XL	46.5	X0SR203XL

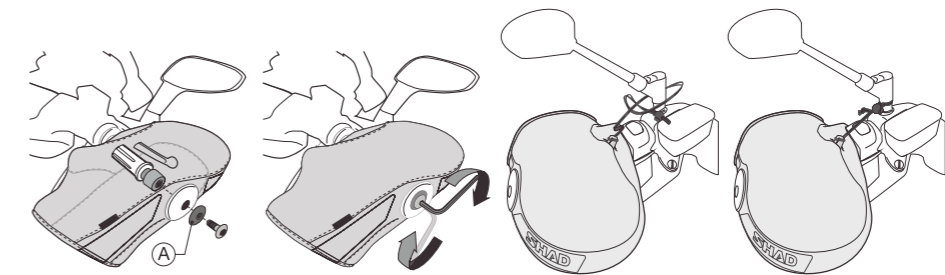

ATV CASES



ATV110

X58.5 Y93 Z34 (cm)
Ref. D0Q1100



X55 Y90 Z26 (cm)
Ref. S0Q800



ATV40

X37 Y74 Z19 (cm)
Ref. D0Q200





FEATURES



PATENT PENDING

- 1 Premium lock cylinder up to 30.000 cycles
- 2 Reversible premium key with more than 10.000 keys combinations
- 3 The head set can rotate 360°
- 4 All components satisfy the REACH environmental Regulation
- 5 Side use of the cylinder lock: more comfortable and great water resistance
- 6 Cylinder lock fitting is inaccessible
- 7 Invisible assembly between the head set and the chain
- 8 Logo and other graphics are pad printed

SERIE 3



SC 307H
Ref. C0S307H



49 cm

SC 305H
Ref. C0S305H



44 cm

SC 303H
Ref. C0S303H



38 cm

SERIE 2



SC 207H
Ref. C0S207H



49 cm

SC 205H
Ref. C0S205H



44 cm

SC 203H
Ref. C0S203H



38 cm

- 1 Premium lock cylinder up to 30.000 cycles
- 2 Reversible premium key with more than 10.000 keys combinations
- 3 The head set can rotate 360°
- 4 All components satisfy the REACH environmental Regulation

FULLY EQUIPPED MOTORCYCLES

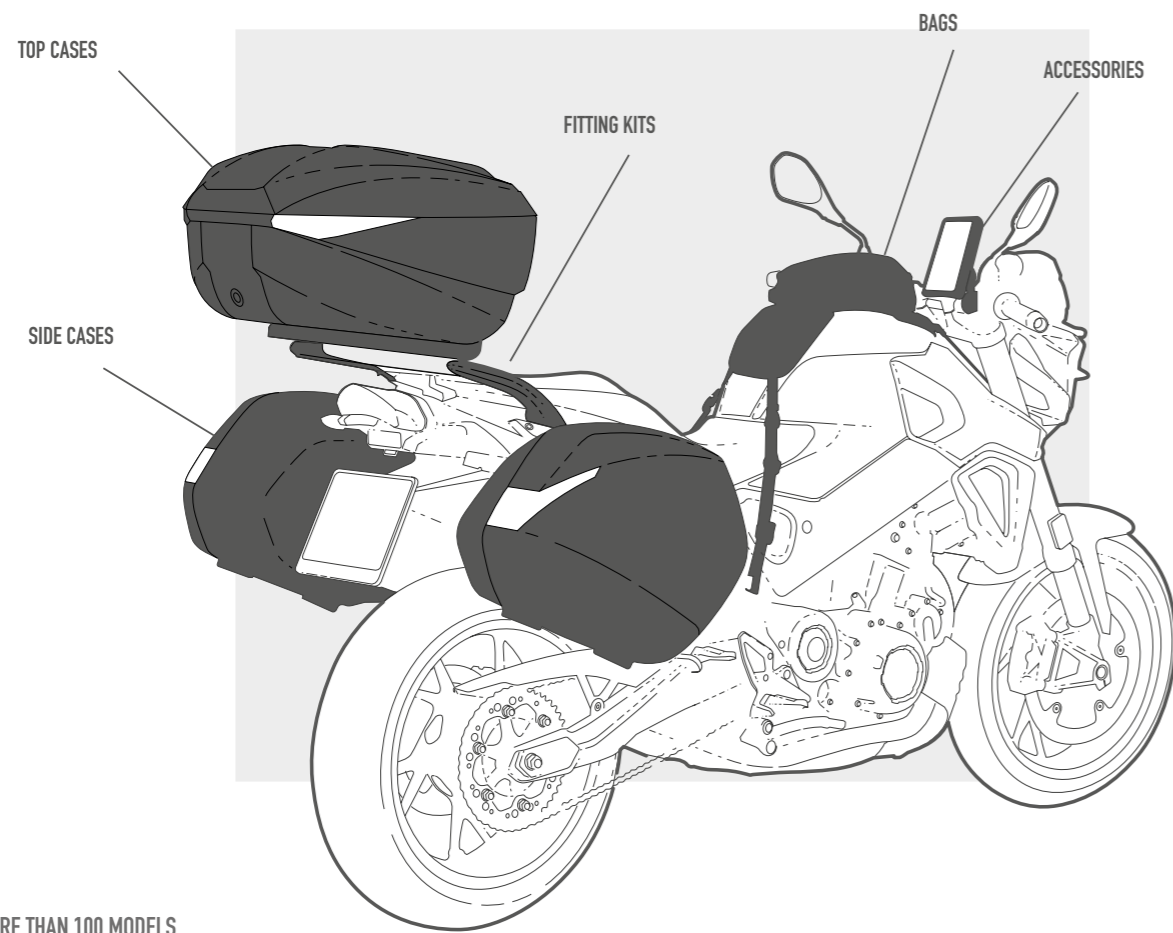

MORE THAN 100 MODELS



CHECK OUR FULLY EQUIPPED CATALOGUES:



SPARE PARTS

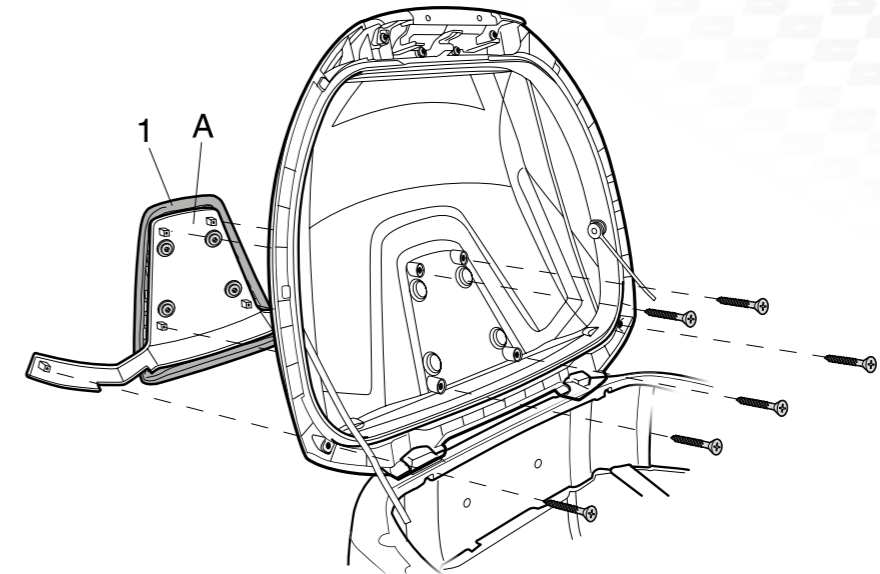

DOWNLOAD OUR SPARE PARTS CATALOGUE



YOUTUBE SUPPORT CHANNEL:
TECHNICAL INFO
SPARE PARTS INSTALLATION
ACCESSORIES MOUNTING GUIDE

SHAD SUPPORT

TOP CASES



SIDE CASES



BAGS



FITTING KITS

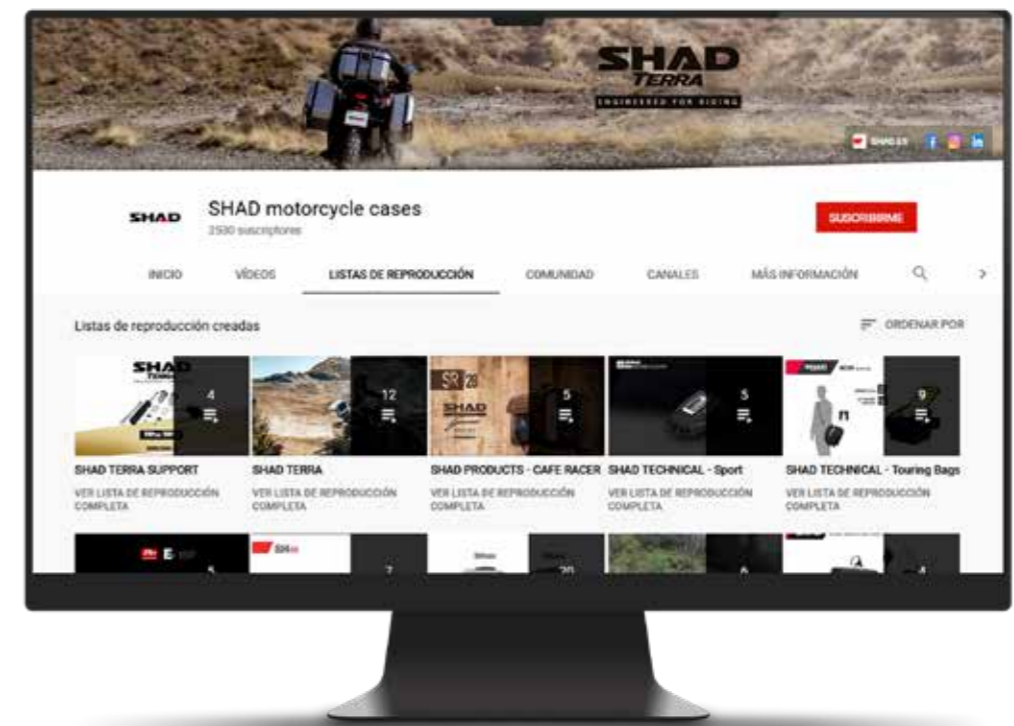

DISPLAYS

9 TOP CASES

REF. D0EX03 (1u.) + D0EX02 (2u.) + D0EX10 (1u.)



SH36/SH35/SH23 DISPLAY

Ref. D0EX201

TERRA DISPLAY

Ref. D0TR201



PIN SYSTEM DISPLAYS

FLOOR STAND: Ref. D0EXPS01

SINGLE TOP CASE DISPLAY

SLATWALL: Ref. D0EXTRR



WALL: Ref. D0EXTRP

RIGHT SIDE WALL DISPLAY

4P SYSTEM: Ref. D0EXP04P



3P SYSTEM: Ref. D0EXPIF



SADDLE BAGS DISPLAY

SR38/SL58/E48/E48SR

WALL: Ref. D0EX19SR



FOR ALL TOP CASES. WITH FLOOR STAND

Ref. D0EX23



3 TOP CASES

Ref. D0EX02



BIG TOP CASES

SH59X-SH58X-SH50-SH49-SH48

Ref. D0EX10



D0EX58



D0EX201

TABLE TOP:

REF. D0EXPS031:
DISPLAY + BAG E04P



ICONS DESCRIPTION



Expandable case



2 flip-up helmets



2 full face helmets



2 helmets: full face and jet



Waterproof IPX5



Handlebar bracket



Mirror Bracket



Safety lock



2 Trail helmets



2 helmets: flip-up and jet



1 flip-up helmet



1 full face helmet



SR Side Bag Holder



Clean



Quick assembly



Practical



1 jet helmet



Maximum load



Secure lock system



SHAD change colour system



Secure



EU Design



Compression straps



Backrest



Inner bag



Upper rack



Light



Inner tray



Capacity



Reflector



Waterproof



Side Bag Holder



Aluminium Mounting Plate



Semi rigid

CIAO HOLA



CATALOGUE LANGUAGES:
Find your translation scanning this QR Code.



NAD

SHAD NETWORK:

SHAD WORLD (BARCELONA)

Octave Lecante 2-6
Pol. Ind. Can Magarola
08100 Mollet del Vallès · Barcelona · Spain
Tel. +34 935 795 866
NAD Clients Tel.: +34 935 795 860
Fax: +34 935 796 945

SHAD ESPAÑA

Teléfono: +34 935 795 870

SHAD FRANCE

Téléphone: +34 935 795 868

SHAD ITALY

Telefono: +34 935 795 867

SHAD USA

19096 NE 4th Court
Miami FL, 33179
USA

SHAD CHINA

士雅的摩托车配件（上海）有限公司
SHAD MOTORCYCLE ACCESSORY
(SHANGHAI) COMPANY LTD.
地址：闵行区泰虹路268弄1号万科时
一区T3栋501室

SHAD INDONESIA

Jl. Kemang Selatan VIII No.56 Unit B
Jakarta 12730 Indonesia
T: (+62) 212271 8560

info@shad.es

WWW.SHAD.ES



Code: 999326 Ed. 1



ISO 9001
ISO 14001
BUREAU VERITAS
Certification

